



AC/DC

ISOMETER® isoGEN423

Insulation monitoring device

for unearthed AC, AC/DC, and DC systems up to 3(N)AC, AC 400 V, DC 400 V

Suitable for the application of generators acc. to standard DIN VDE 0100-551

Software version: D0494 V4.xx



Table of contents

1	General information.....	5
1.1	How to use the manual.....	5
1.2	Indication of important instructions and information.....	5
1.3	Signs and symbols.....	5
1.4	Service and Support.....	5
1.5	Training courses and seminars.....	5
1.6	Delivery conditions.....	6
1.7	Inspection, transport and storage.....	6
1.8	Warranty and liability.....	6
1.9	Disposal of Bender devices.....	6
1.10	Safety.....	7
2	Function.....	8
2.1	Intended use.....	8
2.2	Device features.....	8
2.3	Functional description.....	9
2.3.1	GEn and dc operating modes.....	9
2.3.2	General measuring functions.....	9
2.3.3	Isolation from the system to be monitored.....	10
2.3.4	Monitoring the insulation resistance.....	10
2.3.5	Undervoltage/overvoltage monitoring.....	10
2.3.6	Self test/error codes.....	10
2.3.7	Malfunction.....	11
2.3.8	Signalling assignment of the alarm relays K1/K2.....	12
2.3.9	Measuring and response times.....	12
2.3.10	Password protection (on, OFF).....	13
2.3.11	External test/reset button (T/R).....	13
2.3.12	Fault memory.....	13
2.3.13	History memory HiS.....	13
2.3.14	Interface/protocols.....	13
3	Installation, connection and commissioning.....	15
3.1	Dimensions.....	15
3.2	Mounting.....	15
3.3	Connection.....	15
3.4	Commissioning.....	16

4	Operation.....	18
4.1	Operating and display elements.....	18
4.2	Menu overview.....	20
4.3	Displaying measured values.....	21
4.4	Setting the response values (AL).....	22
4.4.1	Response values overview.....	22
4.4.2	Setting the insulation resistance parameters.....	22
4.4.3	Setting parameters for undervoltage and overvoltage.....	22
4.5	Configuring fault memory, alarm relays, and interfaces (out).....	23
4.5.1	Configuring the relays.....	23
4.5.2	Allocating messages to the relays.....	23
4.5.3	Activating or deactivating fault memory.....	24
4.5.4	Configuring interfaces.....	24
4.6	Setting delay times and self test cycles (t).....	24
4.7	Setting device control parameters (SEt).....	25
4.8	Reset to factory settings.....	25
4.9	Showing and deleting the history memory.....	26
4.10	Querying software version (InF).....	26
5	Data access via interfaces.....	27
5.1	Data access using the BMS protocol.....	27
5.2	IsoData data string.....	27
5.3	Data access using the Modbus RTU protocol.....	28
5.3.1	Reading out the Modbus register from the ISOMETER®.....	28
5.3.2	Writing the Modbus register (parameter setting).....	29
5.3.3	Exception code.....	30
5.3.4	Modbus register assignment.....	31
5.3.5	Device-specific data types.....	34
6	Technical data.....	40
6.1	Tabular representation.....	40
6.2	Standards and certifications.....	45
6.3	Device overview.....	45

1 General information

1.1 How to use the manual



ADVICE

This manual is intended for qualified personnel working in electrical engineering and electronics! Part of the device documentation in addition to this manual is the enclosed supplement "Safety instructions for Bender products".



ADVICE

Read the operating manual before mounting, connecting and commissioning the device. Keep the manual within easy reach for future reference.

1.2 Indication of important instructions and information



DANGER

Indicates a high risk of danger that will result in death or serious injury if not avoided.



WARNING

Indicates a medium risk of danger that can lead to death or serious injury if not avoided.



CAUTION

Indicates a low-level risk that can result in minor or moderate injury or damage to property if not avoided.



Information can help to optimise the use of the product.

1.3 Signs and symbols



Disposal



Protect from moisture



Protect from dust



Temperature range



Recycling



RoHS directives

1.4 Service and Support

Information and contact details about customer service, repair service or field service for Bender devices are available on the following website: Fast assistance | Bender GmbH & Co. KG.

1.5 Training courses and seminars

Regular face-to-face or online seminars for customers and other interested parties:

www.bender.de > know-how > seminars.

1.6 Delivery conditions

The conditions of sale and delivery set out by Bender GmbH & Co. KG apply. These can be obtained in printed or electronic format.

The following applies to software products:



'Software clause in respect of the licensing of standard software as part of deliveries, modifications and changes to general delivery conditions for products and services in the electrical industry'

1.7 Inspection, transport and storage

Check the shipping and device packaging for transport damage and scope of delivery. In the event of complaints, the company must be notified immediately, see "www.bender.de > service & support".

The following must be observed when storing the devices:

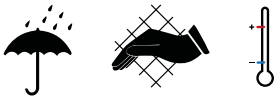

1.8 Warranty and liability

Warranty and liability claims for personal injury and property damage are excluded in the case of:

- Improper use of the device.
- Incorrect mounting, commissioning, operation and maintenance of the device.
- Failure to observe the instructions in this operating manual regarding transport, commissioning, operation and maintenance of the device.
- Unauthorised changes to the device made by parties other than the manufacturer.
- Non-observance of technical data.
- Repairs carried out incorrectly.
- The use of accessories or spare parts that are not provided, approved or recommended by the manufacturer.
- Catastrophes caused by external influences and force majeure.
- Mounting and installation with device combinations not approved or recommended by the manufacturer.

This operating manual and the enclosed safety instructions must be observed by all persons working with the device. Furthermore, the rules and regulations that apply for accident prevention at the place of use must be observed.

1.9 Disposal of Bender devices

Abide by the national regulations and laws governing the disposal of this device.



For more information on the disposal of Bender devices, refer to www.bender.de > service & support.

1.10 Safety

If the device is used outside the Federal Republic of Germany, the applicable local standards and regulations must be complied with. In Europe, the European standard EN 50110 applies.



DANGER *Risk of fatal injury due to electric shock!*

Touching live parts of the system carries the risk of:

- Risk of electrocution due to electric shock
- Damage to the electrical installation
- Destruction of the device

Before installing the device and before working on its connections, make sure that the installation has been de-energised. The rules for working on electrical systems must be observed.

2 Function

2.1 Intended use

The ISOMETER® monitors the insulation resistance R_F of unearthed AC, AC/DC and DC systems (IT systems) with nominal system voltages of 3(N)AC, AC/DC 0...400 V or DC 0...400 V. The maximum permissible system leakage capacitance C_e is 5 μ F. DC components existing in AC systems do not influence the operating characteristics when a minimum load current of DC 10 mA flows. The separate supply voltage U_s allows de-energised systems to be monitored as well.

In order to meet the requirements of the applicable standards, customised parameter settings must be made on the equipment in order to adapt it to local equipment and operating conditions. Please heed the limits of the range of application indicated in the technical data.

Any other use than that described in this manual is regarded as improper.

i *To ensure that the ISOMETER® functions correctly, an internal resistance of ≤ 1 k Ω must exist between L1/+ and L2/- via the source (e.g. the transformer) or the load.*

i *If the ISOMETER® is installed inside a control cabinet, the insulation fault message must be audible and/or visible to attract attention.*

2.2 Device features

- Monitoring of the insulation resistance R_F for unearthed AC/DC systems
- Measuring the nominal system voltage U_n (true RMS) with undervoltage/overvoltage detection
- Selectable start-up delay, response delay and delay on release
- Measuring the residual voltages of the supply system to earth (L1/+, L2/- to PE)
- Two operating modes: GEn and dc
- Automatic adaptation to the system leakage capacitance C_e bis 5 μ F
- Automatic device self test with connection monitoring
- Two separately adjustable response value ranges from 5...200 k Ω (alarm 1, alarm 2)
- Alarms output via LEDs ('AL1', 'AL2'), a display, and alarm relays ('K1', 'K2')
- Selectable N/C or N/O relay operation
- Measured value display via multi-functional LC display
- Fault memory can be activated
- Password protection against unauthorised changing of parameters
- RS-485 (galvanically isolated) including the following protocols:
 - BMS (Bender measuring device interface) for the data exchange with other Bender devices
 - Modbus RTU
 - IsoData (for continuous data output)

2.3 Functional description

2.3.1 GEn and dc operating modes

The **GEn mode** is used in AC/DC or DC systems. In this mode, the device complies with the maximum response time ≤ 1 s for $C_e \leq 1 \mu\text{F}$ and $R_F \leq R_{an}/2$.

The **dc mode** is only used in DC systems. In this mode, the device complies with the maximum response time of ≤ 1 s for $C_e \leq 2 \mu\text{F}$ and $R_F \leq R_{an}/2$ in the event of asymmetrical insulation faults. In case of symmetrical insulation faults, response times of ≤ 10 s for $C_e \leq 5 \mu\text{F}$ and $R_F \leq R_{an}/2$ are complied with. The system leakage capacitance C_e is also measured in this mode.

The operating mode can be changed in the menu 'SET'.

2.3.2 General measuring functions

The ISOMETER® measures the r.m.s. value of the nominal system voltage U_n between L1/+ and L2/- as well as the residual voltages between L1/+ and earth (U_{L1e}) and between L2/- and earth (U_{L2e}).

When it is connected to a **DC supply system** and when a minimum system voltage has been reached, the device determines the faulty conductor L1/+ or L2/-. The fault is indicated by a '+' or '-' sign preceding the measured value. The value range of the display is ± 100 %:

Display	Meaning
-100 %	One-sided fault on conductor L2/-
0 %	Symmetrical fault
+100 %	One-sided fault on conductor L1/+

The partial resistances can be calculated from the total insulation resistance R_F and the resistance of the faulty conductor (R %) using the following formula:

$$\text{Fault on conductor L1/+ } R_{L1F} = (200 \% * R_F) / (100 \% + R \%)$$

$$\text{Fault on conductor L2/- } R_{L2F} = (200 \% * R_F) / (100 \% - R \%)$$

When the ISOMETER® is coupled to an **AC system**, the faulty conductor can only be determined in a connected DC system, and the faulty conductor is detected either on L1/+ (+100 %) or L2/- (-100 %). Calculating the fault distribution is not possible in this case.

The detected fault can be assigned to a relay. If the values R_F or U_n violate the response values activated in the 'AL' menu for the duration t_{on} without interruption, the LEDs and relays 'K1' and 'K2' will respond according to the alarm assignment set in the 'out' menu. In addition, the mode of operation of the relay (n.o./n.c.) can be set, and the fault memory 'M' is activated in this menu.

If the values R_F or U_n no longer violate their respective release values (response value plus hysteresis) for the period t_{off} without interruption, the alarm relays will switch back to their initial position and the alarm LEDs 'AL1'/'AL2' will stop lighting. If the fault memory is activated, the alarm relays remain in alarm condition and the LEDs light until the reset button 'R' is pressed or the supply voltage U_s is interrupted.

The device function can be tested using the test button 'T'. Parameters are assigned to the device via the LCD and the control buttons on the front panel; this function can be password-protected. Parameterisation is also possible via the BMS bus, e.g. by using the BMS Ethernet gateway (COM465IP) or a Modbus RTU.

2.3.3 Isolation from the system to be monitored

If the device has no supply voltage U_s or is in stop mode, it decouples terminals 'L1/+ ' and 'L2/- ' internally from the IT system being monitored. In this case, an insulation resistance measurement up to maximally DC 500 V can be carried out using an insulation tester.

2.3.4 Monitoring the insulation resistance

The insulation resistance R_F is monitored by means of the parameters 'R1' (prewarning) and 'R2' (alarm) (see chapter 4.4). The value 'R1' can only be set higher than the value 'R2'. If the insulation resistance R_F reaches or falls below the activated values 'R1' or 'R2', an alarm message will be signalled. If R_F exceeds the values 'R1' or 'R2' plus the hysteresis value, the alarm will be cleared.

2.3.5 Undervoltage/overvoltage monitoring

The two parameters ('U <' and 'U >') used to monitor the nominal system voltage U_n can be enabled or disabled in the response-value menu 'AL' (chapter 4.4). The maximum undervoltage value is limited by the overvoltage value.

The RMS value of the nominal system voltage U_n is monitored. If the nominal system voltage U_n reaches, falls below, or exceeds the limit values ('U <' and 'U >'), an alarm message will be signalled. If the maximum permissible nominal system voltage U_n set for the ISOMETER® is exceeded, an alarm message will be initiated even when the overvoltage limit value has been deactivated. The alarm will be deleted when the limit values plus hysteresis (chapter 4.4.2) are no longer violated.

2.3.6 Self test/error codes

The **self test** checks the function of the ISOMETER®, and monitors the connection to earth as well as the connection to the system to be monitored. The alarm relays do not switch during an automatically started self test. For a self test started manually, the switching of the alarm relays can be set using the parameter 'test' in the alarm assignment (menu 'out', chapter 4.5.2). During the test, the display indicates 'tES'.

When malfunctions are detected or connections are missing, the LEDs 'ON'/'AL1'/'AL2' flash. The display shows the respective error codes ('E.xx'), and in the factory setting relay 'K2' switches. The relays can be assigned to a device error with the parameter 'Err' in the 'out' menu in the alarm assignment.

In the event of a device error, **error codes** are shown in the display. Some of these are described below:

Error code	Meaning
E.01	<p>PE connection error The connection of 'E' or 'KE' to earth is interrupted. Action: Check connection, eliminate error. The error code will be erased automatically once the error has been eliminated.</p>
E.02	<p>System connection error The internal resistance of the system is too high or the connection of 'L1/+ ' or 'L2/- ' to the system is interrupted. The terminals 'L1/+ ' and 'L2/- ' are connected incorrectly. Action: Check connection, eliminate error. The error code will be erased automatically once the error has been eliminated.</p>

Error code	Meaning
E.03	Reversed polarity connection error Terminals 'L1/+-' and 'L2/-' are connected to the DC system to be monitored with reversed polarity. Detection from $U_n < -30 V_{DC}$
E.05	Measurement error Due to system interferences or a device error, the insulation measured value is no longer updated. Prewarning and alarm are set for the insulation measured value at the same time. Calibration invalid after software update 'E.05' appears together with 'E.08': The software is not compatible to the calibration of the device. Action: Install the previous software version or have the device calibrated at the factory.
E.07	Permissible system leakage capacitance C_e exceeded (only in 'dc' setting) The device is not suitable for the present network leakage capacitance C_e . Action: Uninstall the device.
E.08	Calibration error Action: Check connection, eliminate error. If the error is still present, there is a device error.

Internal device errors 'E.xx' can be caused by external disturbances or internal hardware errors. If the error message occurs again after the device has been restarted or after a reset to the factory settings (menu item 'FAC'), the device must be repaired. After the fault has been eliminated, the alarm relays switch back either automatically or when the reset button is pressed. The self test can take a few minutes.

2.3.6.1 Automatic self test

In the factory setting a self test is carried out when the supply voltage U_s is connected and after that every 24 h. This cycle can be adjusted: off, 1 h, 24 h (see chapter 4.6).

The self test can be suppressed for the device start so that the device can enter the measurement mode more quickly. To this end, set the parameter 'S.Ct = off' in the menu 'SET'.

2.3.6.2 Manual self test

The manual self test is started by pressing the external test/reset button or the test button 'T' on the device for > 1.5 s. Holding the test button 'T' also shows all display elements.

2.3.7 Malfunction

The device checks some of its functions continuously during operation. If a fault is detected, the device error ('err') will be signalled, 'E.xx' appears on the display as an identifier for error type xx, and the LEDs 'ON'/'AL1'/'AL2' will flash.

Please contact Bender Service, if the error occurs again after the device has been restarted or the factory settings have been restored.

2.3.8 Signalling assignment of the alarm relays K1/K2

The notifications for 'device error', 'insulation fault', 'undervoltage/overvoltage fault', 'device test' and 'device start with alarm' can be assigned to the alarm relays via the 'out' menu.

An **insulation fault** is indicated by the messages '+R1', '-R1', '+R2' and '-R2'. Messages '+R1' and '+R2' indicate an insulation fault assigned to conductor L1/+, and the messages '-R1' and '-R2' indicate an insulation fault assigned to conductor L2/-. If an assignment to a conductor is not possible, e.g. due to a symmetrical insulation fault, the respective '+' and '-' messages are set together.

The message 'test' indicates a **device test**.

The message 'S.AL' indicates a **device start with alarm**. When the parameter value is set to 'S.AL = on' and the supply voltage U_s is connected, the ISOMETER® starts with the insulation measured value $R_F = 0 \Omega$ and sets all activated alarms. The alarms will be cleared only when the measured values are up-to-date and no thresholds are exceeded. In the factory setting 'S.AL = off', the ISOMETER® starts without an alarm.



Recommendation: Set parameter value 'S.AL' identical for both relays.

2.3.9 Measuring and response times

Operating time t_{ae}

The operating time t_{ae} is the time required by the ISOMETER® to determine the measured value. For the insulation measured value R_F , the system leakage capacitance C_e , the residual voltages U_{L1e} and U_{L2e} as well as for the faulty conductor L1/+ or L2/- it is dependent on the insulation resistance R_F and the system leakage capacitance C_e . System disturbances may lead to extended measuring times. The measuring time of the nominal system voltage U_n is independent of this and significantly shorter.

Response delay t_{on}

The response delay t_{on} is set uniformly for all messages in the 't' menu using the parameter 'ton', while each alarm message specified in the alarm assignment has its own timer for t_{on} . This delay can be used for interference suppression in the case of short measuring times.

An alarm will only be signalled when a threshold value of the respective measured value is violated for the duration of t_{on} without interruption. Every time the threshold value is violated within the time t_{on} , the response delay 'ton' restarts once again.

Total response time t_{an}

The total response time t_{an} is the sum of the operating time t_{ae} and the response delay t_{on} .

Delay on release t_{off}

The delay on release t_{off} can be set uniformly for all messages using the parameter 'toff', while each alarm message specified in the alarm assignment has its own timer for t_{off} .

An alarm will continue to be signalled until the threshold value of the respective measured value is no longer violated (including hysteresis) for the duration of t_{off} without interruption. Each time a threshold value is no longer violated during t_{off} , the delay on release 'toff' restarts once again.

Start-up delay t

After connecting the supply voltage U_s , the alarm output is suppressed for the time set in parameter 't' (0...10 s).

2.3.10 Password protection (on, OFF)

If password protection is activated (on), settings can only be made after entering the password (0...999). For its activation, see chapter 4.7.

2.3.11 External test/reset button (T/R)

Functions

- Reset = press the external button < 1.5 s drücken
- Reset + self test = press the external button > 1.5 s drücken
- Stop measuring function = press and hold the external button



When the measuring function is stopped, the display shows 'StP'.

The stop function can also be triggered via an interface command, and in this case it can only be reset via the interface.

Only one ISOMETER® may be controlled via an external test/reset button.

A galvanic parallel connection of several test or reset inputs for testing multiple insulation monitoring devices is not allowed.

2.3.12 Fault memory

Disabled (OFF)

The LEDs and relays signal the fault as long as it is detected.

Enabled (ON)

The LEDs and relays signal the fault until a reset is performed or the supply voltage U_s is disconnected.

2.3.13 History memory HiS

The history memory saves exclusively the measured values for the first fault. The history memory must first be cleared before new measured values can be saved.

The values checked in the table in chapter 4.3 can be saved.

2.3.14 Interface/protocols

The ISOMETER® uses the serial hardware interface RS-485 with the following protocols:

• BMS

The BMS protocol is an essential component of the Bender measuring device interface (BMS bus protocol). Data transmission generally makes use of ASCII characters.

• Modbus RTU

Modbus RTU is an application layer messaging protocol, and it provides master/slave communication between devices that are connected via bus systems and networks. Modbus RTU messages have a 16-bit CRC (cyclic redundant checksum), which guarantees reliability.

- **IsoData**

The ISOMETER® sends an ASCII data string with a cycle of approximately 1 second. Communication with the ISOMETER® in this mode is not possible, and no additional sender may be connected via the RS-485 bus cable. The ASCII data string for the ISOMETER® is described in chapter 5.2.

The parameter address, baud rate and parity for the interface protocols are configured in the 'out' menu.

i *With 'Adr = 0', the menu entries baud rate and parity are not shown in the menu and the IsoData protocol is activated.*

With a valid bus address (i.e. not equal to 0), the menu item 'baud rate' is displayed in the menu. The parameter value '---' for the baud rate indicates the activated BMS protocol. In this case, the baud rate for the BMS protocol is set to 9600 baud. If the baud rate is set unequal to '---', the Modbus protocol with configurable baud rate is activated.

i *The IsoData protocol can be cancelled by sending the command 'Adr3' during a non-transmission period of the ISOMETER®.*

3 Installation, connection and commissioning

3.1 Dimensions

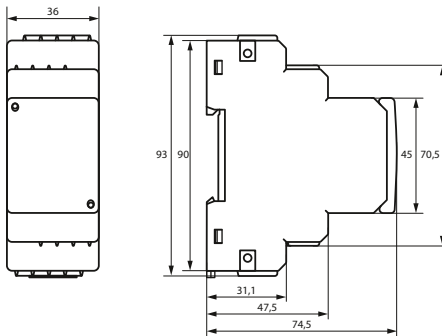

Figure: Dimension diagram

3.2 Mounting

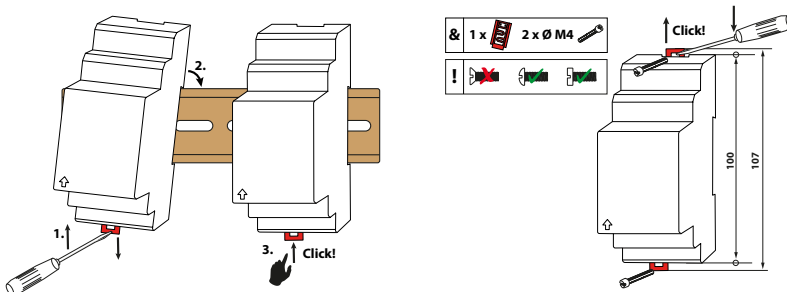

Figure: DIN rail mounting (left) or screw mounting (right)

3.3 Connection



DANGER *Risk of fatal injury due to electric shock!*

Touching live parts of the system carries the risk of:

- Risk of electrocution due to electric shock
- Damage to the electrical installation
- Destruction of the device

Before installing the device and before working on its connections, make sure that the installation has been de-energised. The rules for working on electrical systems must be observed.

For details about the conductor cross sections required for wiring, refer to the technical data beginning with 6.1 Tabular representation.

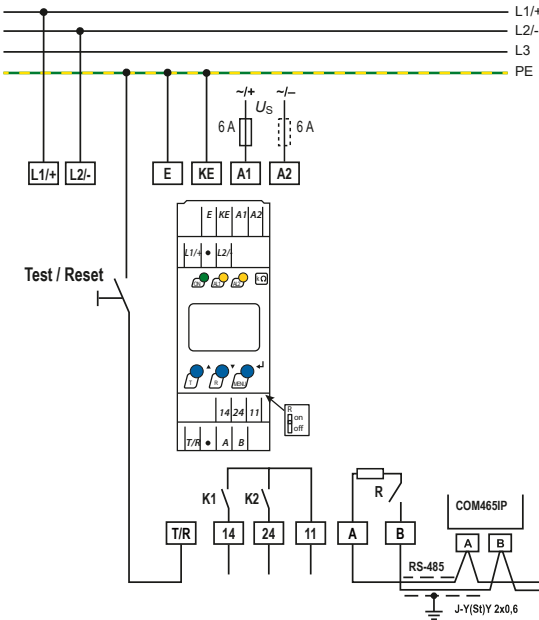

Terminal	Connections
A1, A2	Connection to the supply voltage U_s via fuse (line protection): If supplied from an IT system, both lines have to be protected by a fuse.*
E, KE	Connect each terminal separately to PE: The same wire cross section as for 'A1', 'A2' is to be used.
L1/+, L2/-	Connection to the 3(N)AC, AC or DC system to be monitored
T/R	Connection for the external combined test and reset button
11, 14	Connection to alarm relay 'K1'
11, 24	Connection to alarm relay 'K2'
A, B	RS-485 communication interface with connectable terminating resistor Example: Connection of a BMS Ethernet gateway COM465IP

Figure: Wiring diagram

- i** * **For UL applications:**
Use 60/70 °C copper lines only!
For UL and CSA applications, using 5 A fuses for the protection of the supply voltage U_s is mandatory.

3.4 Commissioning

1. **Check that** the ISOMETER® is **properly connected** to the system to be monitored.
2. **Connect supply voltage** U_s to the ISOMETER®.

The device carries out a calibration, a self test and adjusts itself to the IT system to be monitored. With high system leakage capacitances this process may take up to 4 min. The standard display then appears showing the present insulation resistance, e.g.:

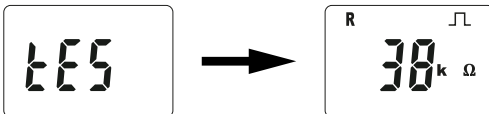

The pulse symbol signals an error-free update of the resistance and capacitance measured values. If the measured value cannot be updated due to disturbances, the pulse symbol will be blanked.

The voltage of the IT system to be monitored can also be selected as standard display: Select measured value display $U_{L1,2}$ with the up and down buttons and accept with ENTER.

3. **Start a manual self test** by pressing the test button 'T'. Whilst the test button is pressed and held down for > 1.5 s, all display elements available for this device are shown. During the test, the 'tES' symbol flashes. Any internal malfunctions detected are shown on the display as error codes (see see chapter 2.3.6.1). The alarm relays are not checked during the test (factory setting). The setting can be changed in the 'out' menu so that the relays switch to the alarm state during the manual self test.
4. **Check factory setting for suitability.**

Are the settings suitable for the installation to be monitored?
The list of factory settings is shown in the tables from chapter 4.4.
5. **Check the function using a genuine insulation fault.**

The ISOMETER® shall be checked against earth in the system being monitored, e.g. via a suitable resistance.



4 Operation



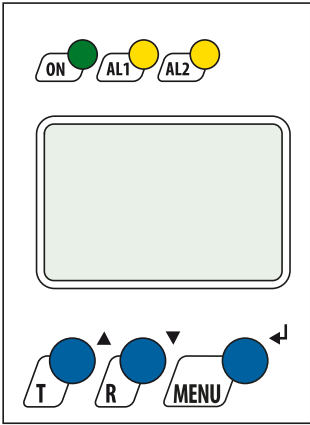



4.1 Operating and display elements

Device front	Operating elements	Function
	ON	● Device is running
	AL1	● Prewarning ◎ Overvoltage
	AL2	● Alarm ◎ Undervoltage
	▲▼	Up and down buttons – For navigating up or down in the menu settings. – For increasing or decreasing values.
	T	Test button (press > 1.5 s)
	R	Reset button (press > 1.5 s)
	↵	Enter button – Select menu item. – Save value.
	MENU	MENU button (press > 1.5 s) – Starts menu mode. – Exits menu item without saving changes.

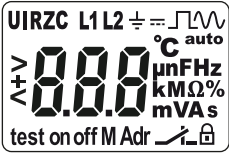
- LED on
- ◎ LED flashes



The 'prewarning' and 'alarm' messages can be assigned to the relays, see chapter 4.5.2.

Display	Display elements	Function
	U	Nominal system voltage U_n
	I	Amperage I_n
	R	Insulation resistance R_F
	Z	Impedance Z_F
	C	System leakage capacitance C_e
	L1 L2 	Monitored conductors
		Voltage type DC
		Pulse symbol: error-free measured value update
		Voltage type AC
	auto	Automatic self test active
	°C μ n F Hz k M Ω % m V A s	Measured values and units
		Password protection is activated
		In the menu mode, the operating mode of the respective alarm relay is displayed.
	Adr	Communication interface with measured value: isoData operation
	M	Fault memory is activated
	on / off	Condition symbols
	test	Self test is active
	> + <	Identification for response values and response value violation



The display parameters that can be configured flash.

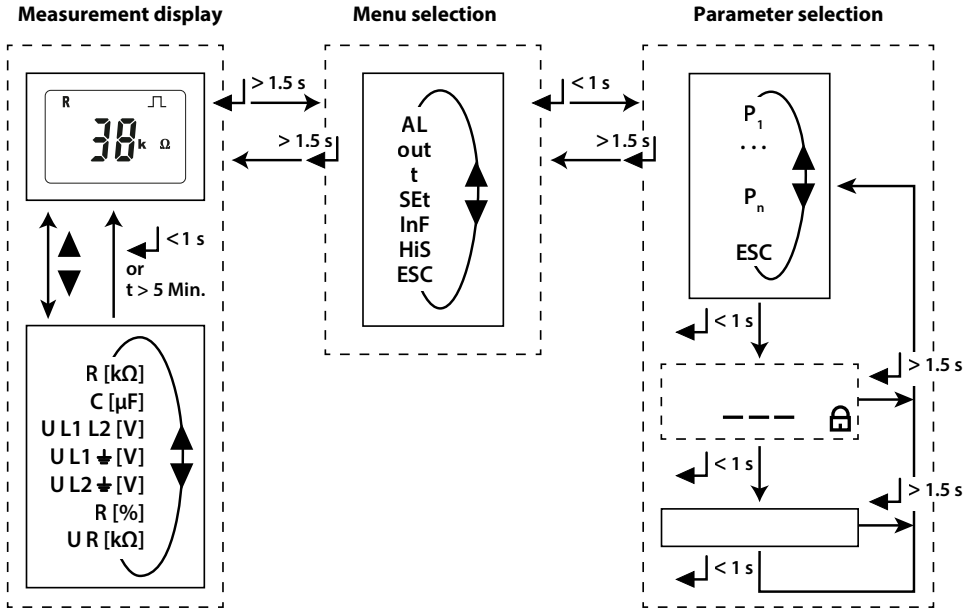

4.2 Menu overview



Menu item	Parameter
AL	Querying and setting response values
out	Configuring fault memory, alarm relays and interface
t	Setting delay times and self test cycles
SEt	Setting device control parameters
InF	Querying software version
HiS	Querying and clearing the history memory
ESC	Going to the next-higher menu level

4.3 Displaying measured values

Overview

HiS	Display	Description	
✓	$\pm R \text{ k}\Omega$ 	Insulation resistance 1 k Ω ... 2 M Ω	R_F^* Resolution 1 k Ω
		The '+' or '-' sign appears, when an error of $R_F < 100 \text{ k}\Omega$ is mainly detected at L1/+ or L2/- with $ R\% \geq 30\%$. In addition, in the DC system U_n must be $\geq 20 \text{ V}$.	
✓	$C \mu\text{F}$ 	System leakage capacitance 1 nF ... 17 μF	C_e Resolution 1 nF
		No update if $R_F < 10 \text{ k}\Omega$.	
✓	$\sim \pm U \text{ L1 L2} = \text{V}$	Nominal system voltage L1 - L2 $0 V_{\text{trueRMS}} \dots 500 V_{\text{trueRMS}}$	U_n^* Resolution $1 V_{\text{trueRMS}}$
		When $U_{\text{RMS}} > 20 \text{ V}$ in a DC system, the '+' or '-' sign indicates the polarity at terminals 'L1/+' and 'L2/-'. The sign '~' indicates an AC system.	
✓	$\pm U \text{ L1} \text{ } \underline{\text{---}} = \text{V}$	Residual voltage L1/+ - PE $0 V_{\text{DC}} \dots \pm 500 V_{\text{DC}}$	U_{L1e} Resolution $1 V_{\text{DC}}$
✓	$\pm U \text{ L2} \text{ } \underline{\text{---}} = \text{V}$	Residual voltage L2/- - PE $0 V_{\text{DC}} \dots \pm 500 V_{\text{DC}}$	U_{L2e} Resolution V_{DC}
✓	$\pm R \%$	Fault location in % -100 % ... +100 % This value is displayed only in the 'dc' setting with a mains voltage $U_n \geq 20 V_{\text{DC}}$. $R_{F+} = (200\% * R_F) / (100\% + x\%)$ $R_{F-} = (200\% * R_F) / (100\% - x\%)$	

✓ The measured value can be displayed in the history memory.

* The measured value can be configured as standard display.

Displaying the current measured values

The standard display shows the currently measured value for R_F or U_n . Press the up or down buttons to display all other measured values. After 5 min. at the latest the display switches back to the standard display.



ADVICE

The pulse symbol indicates a currently measured value. If this symbol does not appear, the measurement is still ongoing and the latest valid measured value will be displayed. The symbols '<' or '>' will be displayed additionally to the measured value when a response value has been reached or violated, or the measured value is below or above the measuring range.

Changing the standard display

R_F oder U_n can be set as the standard display:

1. Use the up or down buttons to go from the standard display to the display you want.
2. Confirm with Enter.

4.4 Setting the response values (AL)

4.4.1 Response values overview

Display	Activation		Setting value			Description
	FAC	Cs	Range	FAC	Cs	
R1 <	on		R2 ... 250	46	kΩ	Prewarning value R_{an1} Hys. = 25 % / min. 1 kΩ
R2 <	on		5 ... R1	23	kΩ	Alarm value R_{an2} Hys. = 25 % / min. 1 kΩ
U <	off		10 ... U >	10	V	Alarm value undervoltage RMS Hys. = 5 % / min. 5 V
U >	off		U < ... 500	500	V	Alarm value Overvoltage Hys. = 5 % / min. 5 V

FAC Factory settings

Cs Customer settings

4.4.2 Setting the insulation resistance parameters

How to proceed

1. Open menu 'AL'.
2. Select parameter 'R1' for prewarning or parameter 'R2' for alarm.
3. Set value and confirm with Enter.

4.4.3 Setting parameters for undervoltage and overvoltage



How to proceed

1. Open menu 'AL'.
2. Select parameter 'U <' for undervoltage or parameter 'U >' for overvoltage.
3. Set value and confirm with Enter.

4.5 Configuring fault memory, alarm relays, and interfaces (out)

Call up menu 'out' to configure fault memory, alarm relays, and interfaces.

4.5.1 Configuring the relays

Relay K1			Relay K2			Description
Display	FAC	Cs	Display	FAC	Cs	
 1	n.c.		 2	n.c.		Operating mode of the relay n.c./n.o.



FAC Factory settings

Cs Customer settings

4.5.2 Allocating messages to the relays

The 'on' setting allocates a message to the corresponding relay. The LED indication is directly assigned to the alarms and is not related to the relays.

If the device can assign an asymmetrical insulation fault to the corresponding conductor (L1/+ or L2/-), it will only signal the respective alarm. If not, the alarm messages L1/+ and L2/- are signalled together.

K1 'r1'			K2 'r2'			LEDs			Alarm description
Display	FAC	Cs	Display	FAC	Cs	ON	AL1	AL2	
 1 Err	off		 2 Err	on		⊙	⊙	⊙	Device error E.xx
r1 +R1 < Ω	on		r2 +R1 < Ω	off		●	●	○	Prewarning R1 Fault R_f at L1/+
r1 -R1 < Ω	on		r2 -R1 < Ω	off		●	●	○	Prewarning R1 Fault R_f at L2/-
r1 +R2 < Ω	off		r2 +R2 < Ω	on		●	○	●	Alarm R2 Fault R_f at L1/+
r1 -R2 < Ω	off		r2 -R2 < Ω	on		●	○	●	Alarm R2 Fault R_f at L2/-
r1 U < V	off		r2 U < V	on		●	○	⊙	Alarm U_n Undervoltage
r1 U > V	off		r2 U > V	on		●	⊙	○	Alarm U_n Overvoltage
r1 test	off		r2 test	off		●	●	●	Manually started device test

K1 'r1'			K2 'r2'			LEDs			Alarm description
Display	FAC	Cs	Display	FAC	Cs	ON	AL1	AL2	
S.AL	off		S.AL	off		●	●	●	Device start with alarm

- FAC Factory settings
- Cs Customer settings
- LED off
- ⊙ LED flashes
- LED on

4.5.3 Activating or deactivating fault memory

Display	FAC	Cs	Description
M	off		Memory function for alarm messages (fault memory)

- FAC Factory settings
- Cs Customer settings

4.5.4 Configuring interfaces

Display	Setting value				Description
	Range	FAC	Cs		
Adr	0/3...90	3	()	Bus Adr.	Adr = 0 deactivates BMS as well as Modbus and activates isoData with continuous data output (115k2, 8E1)
Adr 1	---/ 1.2 k...115 k	'---	()	Baud rate	'---': BMS bus (9k6, 7E1) '1.2k' ... '115k' --> Modbus (variable)
Adr 2	8E1 8o1 8n1 8n2	8E1	()	Modbus	8E1 - 8 data bits, even parity, 1 stop bit 8o1 - 8 data bits, odd parity, 1 stop bit 8n1 - 8 data bits, no parity, 1 stop bit 8n2 - 8 data bits, no parity, 2 stop bits

- FAC Factory settings
- Cs Customer settings
- () Customer setting that is not modified by FAC.

i Adr 2 can only be selected, if Adr 1 is not '---'.

4.6 Setting delay times and self test cycles (t)

Open menu 't' to configure the times.

Display	Setting value			Description
	Range	FAC	Cs	
t	0...10	0	s	Start-up delay when starting the device
ton	0...99	0	s	Response delay K1 and K2
toff	0...99	0	s	Delay on release K1 and K2
test	OFF/1/24	24	h	Repetition time for device test

FAC Factory settings

Cs Customer settings

4.7 Setting device control parameters (SET)

Open menu 'SET' to configure the device control.

Display	Activation		Setting value			Description
	FAC	Cs	Range	FAC	Cs	
	off		0..999	0		Password for parameter setting
GEn dc			GEn dc	GEn		Selection of the system to be monitored GEn: generators (AC, AC with connected DC, DC) dc: DC system
nEt	on					Test of the system connection during device test
S.Ct	on					Device test during device start
FAC						Restore factory settings
SYS						For Bender Service only

FAC Factory settings

Cs Customer settings

4.8 Reset to factory settings

All settings with the exception of the interface parameters are reset to the factory settings.

1. Press MENU button (> 1.5 s).
2. Go to 'SET' and confirm with Enter.
3. Go to 'FAC' and confirm with Enter.

4.9 Showing and deleting the history memory



ADVICE

The history memory saves the measured values for the first fault only. To this end, the history memory must be empty.

Show history memory

Call up 'HiS' menu and go up or down.

Delete history memory

Call up 'HiS' menu, go to 'Clr' and confirm.

4.10 Querying software version (InF)

The software version is displayed as a ticker. Afterwards it can be output step by step using the up or down buttons.

How to proceed

1. Press MENU button (> 1.5 s).
2. Go to 'InF' and confirm with Enter.
3. If necessary, use up or down buttons to display it step by step.

5 Data access via interfaces

5.1 Data access using the BMS protocol

The BMS protocol is an essential component of the Bender measuring device interface (BMS bus protocol). Data transmission generally makes use of ASCII characters.

BMS channel no.	Operation value	Alarm
1	R_F	Prewarning R1
2	R_F	Alarm R2
3		
4	U_n	Undervoltage
5	U_n	Overvoltage
6		Connection fault, earth (E.01)
7		Connection fault, system (E.02)
8		All other device errors (E.xx)
9	Fault location [%]	
10	C_e	
11		
12	Update counter	
13	U_{L1e}	
14	U_{L2e}	
15		

5.2 IsoData data string

In IsoData mode the ISOMETER® sends the entire data string roughly once per second. Communication with the ISOMETER® in this mode is not possible and no additional sender may be connected via the RS-485 bus cable.

IsoData is activated in the menu 'out', menu item 'Adr', when Adr is set to 0. If this is the case, the symbol 'Adr' flashes on the measured value display.

String	Beschreibung
!;	Start symbol
v;	Insulation fault location '' / '+' / '-'
1234, 5;	Insulation resistance R_F [kΩ]
12345;	System leakage capacitance C_e [nF] (in 'GEn' setting only)

String	Beschreibung
123456;	Reserved
+1234;	Nominal system voltage U_n [V_{trueRMS}] Nominal system voltage type: AC or unknown: '' DC: '+' / '-'
+1234;	Residual voltage U_{L1e} [V_{DC}]
+1234;	Residual voltage U_{L2e} [V_{DC}]
+123;	Insulation fault location -100 ... +100 [%]
123456	reserviert
1234;	Alarm message [hexadecimal] (without leading '0x') The alarms are included in this value with the OR function. Assignment of the alarms: 0x0002 device error 0x0004 Prewarning insulation resistance R_F at L1/+ 0x0008 Prewarning insulation resistance R_F at L2/- 0x000C Prewarning insulation resistance R_F symmetrical 0x0010 Alarm insulation resistance R_F at L1/+ 0x0020 Alarm insulation resistance R_F at L2/- 0x0030 Alarm insulation resistance R_F symmetrical 0x0040 Alarm undervoltage U_n 0x0080 Alarm overvoltage U_n 0x0100 Message system test 0x0200 Device start with alarm
12	Update counter, consecutively counts from 0 to 9. It increases with the update of the insulation resistance value.
<CR><LF>	String end

5.3 Data access using the Modbus RTU protocol

Requests to the ISOMETER® can be made using the function code 0x03 (read holding registers) or the function code 0x10 (Write Multiple Registers). The ISOMETER® generates a function-related answer and sends it back.

5.3.1 Reading out the Modbus register from the ISOMETER®

The required Words of the process image can be read out from the ISOMETER® 'Holding Registers' using function code 0x03. For this purpose, the start address and the number of the registers to be read out must be entered. Up to 125 Words (0x7D) can be read out with one single request.

Command of the master to the ISOMETER®

In the following example, the master of the ISOMETER® requests the content of register 1003 using address 3. The register contains the channel description of measuring channel 1.

Byte	Name	Example
Byte 0	ISOMETER® Modbus address	0x03
Byte 1	Function code	0x03
Byte 2, 3	Start address	0x03EB
Byte 4, 5	Number of registers	0x0001
Byte 6, 7	CRC16 checksum	0xF598

Answer of the ISOMETER® to the master

Byte	Name	Example
Byte 0	ISOMETER® Modbus address	0x03
Byte 1	Function code	0x03
Byte 2	Number of data bytes	0x02
Byte 3, 4	Data	0x0047
Byte 7, 8	CRC16 checksum	0x81B6

5.3.2 Writing the Modbus register (parameter setting)

Registers in the device can be modified with function code 0x10 (Preset Multiple Registers). Parameter registers start with address 3000. The content of the registers is listed in the table in chapter 5.3.4.

Command of the master to the ISOMETER®

In this example, address 3 is used to set the content of register address 3003 to 2 in the ISOMETER®.

Byte	Name	Example
Byte 0	ISOMETER® Modbus address	0x03
Byte 1	Function code	0x10
Byte 2, 3	Start register	0x0BBB
Byte 4, 5	Number of registers	0x0001
Byte 6	Number of data bytes	0x02
Byte 7, 8	Data	0x0002
Byte 9, 10	CRC16 checksum	0x9F7A

The ISOMETER® answers the master

Byte	Name	Example
Byte 0	ISOMETER® Modbus address	0x03
Byte 1	Function code	0x10
Byte 2, 3	Start register	0x0BBB
Byte 4, 5	Number of registers	0x0001
Byte 6, 7	CRC16 checksum	0x722A

5.3.3 Exception code

If the ISOMETER® cannot respond to a request, it will send an exception code with which possible faults can be narrowed down.

Exception code	Description
0x01	Impermissible function
0x02	Impermissible data access
0x03	Impermissible data value
0x04	Internal fault
0x05	Acknowledgement of receipt (answer will be time-delayed)
0x06	Request not accepted (repeat request if necessary)

Structure of the exception code

Byte	Name	Example
Byte 0	ISOMETER® Modbus address	0x03
Byte 1	Function code (0x03) + 0x80	0x83
Byte 2	Data (exception code)	0x04
Byte 3, 4	CRC16 checksum	0xE133

5.3.4 Modbus register assignment

Depending on the device condition, the information in the registers is the measured value without alarm; the measured value with alarm 1, the measured value with alarm 2, or only the device error. For more information see AT&T = Alarm type and test type (internal/external), page 35.

Register	Measured value			Device error
	Without alarm	Alarm 1 (prewarning)	Alarm 2 (alarm)	
1000...1003	R_F Insulation fault (71)	R_F Insulation fault (1)	R_F Insulation fault (1)	Earth connection (102)
1004...1007				
1008...1011	U_n Voltage (76)	U_n Overvoltage (78)	U_n Undervoltage (77)	Connection to system (101)
1012...1015	C_e Capacitance (82)			
1016...1019	U_{L1e} Voltage (76)			
1020...1023	U_{L2e} Voltage (76)			
1024...1027	Fault location in % (1022)			
1028...1031	R_{FU} Insulation fault (71)			
1032...1035	Measured value update counter (1022)			Device error (115)

() channel description code (see 'Channel descriptions')

Register	Property	Description	Format	Unit	Value range
3000	RW	Reserved			
3001	RW	Reserved			
3002	RW	Reserved			
3003	RW	Reserved			
3004	RW	Reserved			
3005	RW	Prewarning value Resistance measurement 'R1'	UINT 16	kΩ	R2 ... 250

Register	Property	Description	Format	Unit	Value range
3006	RW	Reserved			
3007	RW	Alarm value resistance measurement 'R2'	UINT 16	kΩ	5 ... R1
3008	RW	Activation alarm value undervoltage 'U <'	UINT 16		0 = Inactive 1 = Active
3009	RW	Alarm value undervoltage 'U <'	UINT 16	V	10 ... U >
3010	RW	Activation alarm value overvoltage 'U >'	UINT 16		0 = Inactive 1 = Active
3011	RW	Alarm value overvoltage 'U >'	UINT 16	V	U < ... 500
3012	RW	Memory function for alarm messages (fault memory) 'M'	UINT 16		0 = Inactive 1 = Active
3013	RW	Operating mode of relay 1 'r1'	UINT 16		0 = n.o. 1 = n.c.
3014	RW	Operating mode of relay 2 'r2'	UINT 16		0 = n.o. 1 = n.c.
3015	RW	Bus address 'Adr'	UINT 16		0 / 3 ... 90
3016	RW	Baud rate 'Adr 1'	UINT 16		0 = BMS 1 = 1.2 k 2 = 2.4 k 3 = 4.8 k 4 = 9.6 k 5 = 19.2 k 6 = 38.4 k 7 = 57.6 k 8 = 115.2 k
3017	RW	Parity 'Adr 2'	UINT 16		0 = 8N1 1 = 8O1 2 = 8E1
3018	RW	Start-up delay 't' during device start	UINT 16	s	0 ... 10
3019	RW	Response delay 'ton' for relays 'K1' and 'K2'	UINT 16	s	0 ... 99
3020	RW	Delay on release 'toff' for relays 'K1' and 'K2'	UINT 16	s	0 ... 99

Register	Property	Description	Format	Unit	Value range
3021	RW	Repetition time 'test' for automatic device test	UINT 16		0 = OFF 1 = 1 2 = 24 h
3022	RW	Reserved			
3023	RW	System and function selection	UINT 16		0 = GEn 1 = dc
3024	RW	Test of the system connection during device test 'nEt'	UINT 16		0 = Inactive 1 = Active
3025	RW	Device test during device start 'S. Ct'	UINT 16		0 = Inactive 1 = Active
3026	RW	Request stop mode (0 = deactivate device)	UINT 16		0 = Stop 1 = ---
3027	RW	Alarm assignment of relay 1 'r1'	UINT 16		Bit 9 ... Bit 1 (See 'Alarm assignment of the relays')
3028	RW	Alarm assignment of relay 2 'r2'	UINT 16		Bit 9 ... Bit 1 (See 'Alarm assignment of the relays')
8003	WO	Factory settings for all parameters	UINT 16		0x6661 'fa'
8004	WO	Factory setting only for parameters resettable by FAC	UINT 16		0x4653 'FS'
8005	WO	Start device test	UINT 16		0x5445 'TE'
8006	WO	Clear fault memory	UINT 16		0x434C 'CL'
9800 ... 9809	RO	Device name	UNIT 16 (ASCII) (see 'Device name')		
9820	RO	Software identification number	UINT 16		Software ID number
9821	RO	Software version number	UINT 16		Software version
9822	RO	Software version: Year	UINT 16		
9823	RO	Software version: Month	UINT 16		

Register	Property	Description	Format	Unit	Value range
9824	RO	Software version: Day	UINT 16		
9825	RO	Modbus driver version	UINT 16		

RO Read only
 RW Read/Write
 WO Write only

5.3.5 Device-specific data types

Device name

The data format of the device name consists of ten Words with two ASCII characters each.

0x00	0x01	0x02	0x03	0x04	0x05	0x06	0x07	0x08	0x09
------	------	------	------	------	------	------	------	------	------

Measured values

Each measured value is available as a channel and consists of 8 bytes (4 registers). The first measured value register address is 1000. The structure of a channel is always the same. Content and number depend on the device. The structure of a channel is shown with the example of channel 1:

1000		1001		1002		1003	
HiByte	LoByte	HiByte	LoByte	HiByte	LoByte	HiByte	LoByte
Floating point value (Float)				Alarm type and test type (AT&T)	Range and unit (R&U)	Channel description	

Float = Floating point value of the channels

Representation of the bit order for processing analogue measured values according to IEEE 754

Word	0x00																0x01															
Byte	HiByte								LoByte								HiByte								LoByte							
Bit	31	30	29	28	27	26	25	24	23	22	21	20	19	18	17	16	15	14	13	12	11	10	9	8	7	6	5	4	3	2	1	0
	S	E	E	E	E	E	E	E	E	M	M	M	M	M	M	M	M	M	M	M	M	M	M	M	M	M	M	M	M	M	M	M

E exponent
 M mantissa
 S sign

AT&T = Alarm type and test type (internal/external)

Bit	7	6	5	4	3	2	1	0	Meaning
	Test external	Test internal	Reserved	Reserved	Reserved	Alarm	Fault		
Alarm type	X	X	X	X	X	0	0	0	No alarm
	X	X	X	X	X	0	0	1	Prewarning
	0	0	X	X	X	0	1	0	Device error
	X	X	X	X	X	0	1	1	Reserved
	X	X	X	X	X	1	0	0	Warning
	X	X	X	X	X	1	0	1	Alarm
	X	X	X	X	X	1	1	0	Reserved
	X	X	X	X	X	1	1	1	Reserved
Test	0	0	X	X	X	X	X	X	No test
	0	1	X	X	X	X	X	X	Internal test
	1	0	X	X	X	X	X	X	External test

- Bits 0 to 2: coding for the alarm type
- Bits 3 to 5: reserved; value 0
- Bit 6 oder 7: set when an internal or external test has been completed

Other values are reserved. The complete byte is calculated from the sum of the alarm type and the test type.

R&U = Range and unit

Bit	7	6	5	4	3	2	1	0	Meaning
Unit	-	-	-	0	0	0	0	0	Invalid (init)
	-	-	-	0	0	0	0	1	No unit
	-	-	-	0	0	0	1	0	Ω
	-	-	-	0	0	0	1	1	A
	-	-	-	0	0	1	0	0	V
	-	-	-	0	0	1	0	1	%
	-	-	-	0	0	1	1	0	Hz
	-	-	-	0	0	1	1	1	Baud
	-	-	-	0	1	0	0	0	F
	-	-	-	0	1	0	0	1	H
	-	-	-	0	1	0	1	0	°C
	-	-	-	0	1	0	1	1	°F
	-	-	-	0	1	1	0	0	Second
	-	-	-	0	1	1	0	1	Minute
	-	-	-	0	1	1	1	0	Hour
-	-	-	0	1	1	1	1	Day	
-	-	-	1	0	0	0	0	Month	
Range of validity	0	0	X	X	X	X	X	X	Actual value
	0	1	X	X	X	X	X	X	The actual value is lower
	1	0	X	X	X	X	X	X	The actual value is higher
	1	1	X	X	X	X	X	X	Invalid value

- Bits 0 to 4: coding for the unit
- Bits 6 and 7: validity range of a value
- Bit 5: reserved

The complete byte is calculated from the sum of the unit and the range of validity.

Alarm assignment of the relays

Several alarms can be assigned to each relay. For the assignment to each relay, a 16-bit register is used with the bits described below. The following table applies to relay 1 and relay 2, in which 'x' stands for the relay number. A set bit activates the specified function.

Bit	Display indication	Meaning
0	Reserved	When reading, always 0 When writing, any value.
1	 x Err	Device error E.xx
2	rx +R1 < Ω	Prewarning R1 Fault R_F at L1/+
3	rx -R1 < Ω	Prewarning R1 Fault R_F at L2/-
4	rx +R2 < Ω	Alarm R2 Fault R_F at L1/+
5	rx -R2 < Ω	Alarm R2 Fault R_F at L2/-
6	rx $U < V$	Message U_n - undervoltage
7	rx $U > V$	Message U_n - overvoltage
8	rx test	Manually started self test
9	S.AL	Device start with alarm
10	Reserved	When reading: 0; When writing: any value
11	Reserved	When reading: 0 When writing: any value
12	Reserved	When reading: 0; When writing: any value
13	Reserved	When reading: 0; When writing: any value
14	Reserved	When reading: 0; When writing: any value
15	Reserved	When reading: 0; When writing: any value

Channel descriptions

Value	Description of measured value / message	Comments
0		
1 (0x01)	Insulation fault	
71 (0x47)	Insulation fault	Insulation resistance R_F in Ω
76 (0x4C)	Voltage	Measured value in V
77 (0x4D)	Undervoltage	
78 (0x4E)	Overvoltage	
82 (0x52)	Capacitance	Measured value in F
86 (0x56)	Insulation fault	Impedance Z_I
101 (0x65)	System connection	
102 (0x66)	Earth connection	
115 (0x73)	Device error	ISOMETER® fault
129 (0x81)	Device error	
145 (0x91)	Own address	

To convert parameter data, data type descriptions are required. Showing text is not necessary in this case.

Value	Description of parameters
1023 (0x3FF)	Parameter/measured value invalid. The menu item of this parameter is not displayed.
1022 (0x3FE)	No measured value / no message
1021 (0x3FD)	Measured value/parameter inactive
1020 (0x3FC)	Measured value/parameter only temporarily inactive (e.g. while a new parameter is transmitted). Indication in the menu '...':
1019 (0x3FB)	Parameter/measured value (value) unit not displayed
1018 (0x3FA)	Parameter (code selection menu) unit not displayed
1017 (0x3F9)	String max. 18 characters (e.g. device type, device variant, ...)
1016 (0x3F8)	
1015 (0x3F7)	Time
1014 (0x3F6)	Date: Day
1013 (0x3F5)	Date: Month
1012 (0x3F4)	Date: Year
1011 (0x3F3)	Register address

Value	Description of parameters
1010 (0x3F2)	Time
1009 (0x3F1)	Multiplication factor [*]
1008 (0x3F0)	Division factor [/]
1007 (0x3EF)	Baud rate

6 Technical data

6.1 Tabular representation

(*) = Factory settings

Insulation coordination acc. to IEC 60664-1/IEC 60664-3

Definitions

Measuring circuit (IC1)	L1/+, L2/-
Supply circuit (IC2)	A1, A2
Output circuit (IC3)	11, 14, 24
Control circuit (IC4)	E, KE, T/R, A, B

Rated voltage	400 V
Overtoltage category III	III

Rated impulse voltage

IC1/(IC2-4)	6 kV
IC2/(IC3-4)	4 kV
IC3/(IC4)	4 kV

Rated insulation voltage

IC1/(IC2-4)	400 V
IC2/(IC3-4)	250 V
IC3/(IC4)	250 V
Pollution degree	3

Safe isolation (reinforced insulation) between

IC1/(IC2-4)	Overtoltage category III, 600 V
IC2/(IC3-4)	Overtoltage category III, 300 V
IC3/(IC4)	Overtoltage category III, 300 V

Voltage test (routine test) according to IEC 61010-1

IC2/(IC3-4)	AC 2.2 kV
IC3/(IC4)	AC 2.2 kV

Supply voltage

Supply voltage U_s	AC 100...240 V / DC 24...240
Tolerance of U_s	-30 ... +15 %
Frequency range of U_s	47...63 Hz
Power consumption	≤ 3 W, ≤ 9 VA

Monitored IT system

Nominal system voltage U_n	3(N)AC, AC, DC 0...400 V
Tolerance of U_n	+25 %
Frequency range of U_n	DC, 35...460 Hz

Measuring circuit

Measuring voltage U_m	±12 V
Measuring current I_m at $R_F, Z_F = 0 \Omega$	≤ 110 μ A
Internal resistance R_{iF}, Z_i	≥ 115 k Ω
Permissible system leakage capacitance C_e	≤ 5 μ F
Permissible extraneous DC voltage U_{fg}	≤ 700 V

Response values

Response value R_{an1}	$R_{an2} \dots 250 \text{ k}\Omega$ (46 k Ω)*
Response value R_{an2}	5 k $\Omega \dots R_{an1}$ (23 k Ω)*
Relative uncertainty of R_{an}	±15 %, at least ±2 k Ω
Hysteresis R_{an}	25 %, at least 1 k Ω
Undervoltage detection $U <$	10 V ... $U >$ (off/10 V)*
Overvoltage detection $U >$	$U < \dots 500 \text{ V}$ (off/500 V)*
Relative uncertainty of U	±5 %, at least ±5 V
Relative uncertainty depending on the frequency ≥ 400 Hz	-0.015 %/Hz
Hysteresis U	5 %, at least 5 V

Time response

Response-time t_{an} at $R_F = 0.5 \times R_{an}$ and $C_e = 1 \mu\text{F}$ in accordance with IEC 61557-8 $\leq 10 \text{ s}$

Start-up delay t	0...10 s (0 s)*
Response delay t_{on}	0...99 s (0 s)*
Delay on release t_{off}	0...99 s (0 s)*

Displays, memory

Indication	LC display, multi-functional, not illuminated
Display range, measured value, insulation resistance (R_F)	1 k Ω ... 2 M Ω
Operating uncertainty	$\pm 15 \%$, at least $\pm 2 \text{ k}\Omega$
Display range, measured value, nominal system voltage (U_n)	0...500 V _{RMS}
Operating uncertainty	$\pm 5 \%$, at least $\pm 5 \text{ V}$
Display range, measured value, system leakage capacitance at $R_F > 10 \text{ k}\Omega$ ('dc' mode only)	0...17 μF
Operating uncertainty at $R_F \geq 20 \text{ k}\Omega$ and $C_e \leq 5 \mu\text{F}$	$\pm 5 \%$, at least $\pm 0.1 \mu\text{F}$
Password	off / 0...999 (0, off)*
Fault memory alarm messages	on / (off)*

Interface

Interface/protocol	RS-485/BMS, Modbus RTU, isoData
Baud rate	BMS: 9.6 kbit/s Modbus RTU: selectable isoData: 115.2 kbits/s
Cable length (9.6 kbits/s)	$\leq 1200 \text{ m}$
Cable: shield connected to PE on one side [alternative: twisted pairs, shield connected to PE on one side]	Recommended: CAT6/CAT7 min. AWG23 [min. J-Y(St)Y 2 x 0.8]
Terminating resistor	120 Ω (0.25
Device address, BMS bus, Modbus RTU	3...90 (3)*

Switching elements

Switching elements	2 x 1 N/O contacts, common terminal 11
Relay mode	NC operation/NO operation (NO operation)*
Electrical endurance at rated operating conditions	10,000 operating cycles

Contact data acc. to IEC 60947-5-1

Utilisation category	AC-12 / AC-14 / DC-12 / DC-12 / DC-12
Rated operational voltage	230 V / 230 V / 24 V / 110 V / 220 V
Rated operational current	5 A / 2 A / 1 A / 0.2 A / 0.1 A
Necessary min. contact load (relay manufacturer's reference)	1 mA at AC/DC \geq 10 V

Environment/EMC

EMC	IEC 61326-2-4
-----	---------------

Ambient temperatures

Operation	-40...+70 °C
Transport	-40...+85 °C
Storage	-40...+70 °C

Climatic classes acc. to IEC 60721

Stationary use (IEC 60721-3-3)	3K22
Transport (IEC 60721-3-2)	2K11
Long-term storage (IEC 60721-3-1)	1K22

Classification of mechanical conditions acc. to IEC 60721

Stationary use (IEC 60721-3-3)	3M11
for W variant	3M12
Transport (IEC 60721-3-2)	2M4
Long-term storage (IEC 60721-3-1)	1M12

Connection

Screw-type terminals

Nominal current	≤ 10 A
Tightening torque	0.5...0.6 Nm (5...7 lb-in)
Conductor sizes	AWG 24-12
Stripping length	8 mm
Rigid/flexible	0.2...2.5 mm ²
Flexible with ferrules with/without plastic sleeve	0.25...2.5 mm ²

Multi-conductor

rigid /flexible	0.2...1.5 mm ²
flexible with ferrules without plastic sleeve	0.25...1.5 mm ²
flexible with TWIN ferrules with plastic sleeve	0.5...1.5 mm ²

Push-wire terminals

Nominal current	≤ 10 A
Conductor sizes	AWG 24-14
Stripping length	10 mm
Rigid	0.2...2.5 mm ²
Flexible without ferrules	0.75...2.5 mm ²
Flexible with ferrules with/without plastic sleeve	0.25...2.5 mm ²
Multi-conductor flexible with TWIN ferrules with plastic sleeve	0.5...1.5 mm ²
Opening force	50 N
Test opening, diameter	2.1 mm

Other

Operating mode	continuous operation
Mounting direction	cooling slots must be ventilated vertically
Degree of protection, internal components (DIN EN 60529)	IP30
Degree of protection, terminals (DIN EN 60529)	IP20
Enclosure material	polycarbonate
DIN rail mounting acc. to	IEC 60715
Screw mounting	2 x M4 with mounting clip

Weight ≤ 150 g

Option W isoGEN423-D4W-4 for use in special climatic conditions

6.2 Standards and certifications

The ISOMETER® was developed in compliance with the standards specified in the Declaration of Conformity.



EU Declaration of Conformity

Hereby, Bender GmbH & Co. KG declares that the device covered by the Radio Directive complies with Directive 2014/53/EU. The full text of the EU Declaration of Conformity is available at the following Internet address:

https://www.bender.de/fileadmin/content/Products/CE/CEKO_isoXX425.pdf

UKCA Declaration of Conformity

Hereby, Bender GmbH & Co. KG declares that this device is in compliance with Radio Equipment Regulations 2017 (S.I. 2017/1206). The full text of the UK declaration of conformity is available at the following internet address:

https://www.bender.de/fileadmin/content/Products/UKCA/UKCA_isoXX425.pdf

6.3 Device overview

Model	Supply voltage U_s	Article number
isoGEN423-D4-4	3(N)AC, AC/DC 0...400 V	B71036325 ¹⁾ B91036325 ²⁾
isoGEN423-D4W-4		B71036325W ¹⁾³⁾

1) Push-wire terminal version

2) Screw-type terminal version

3) Option W: Increased shock and vibration resistance 3K23; 3M12; -40...+70 °C

Accessories

Description	Article number
Mounting clip for screw mounting	B98060008
XM420 mounting frame	B990994



Bender GmbH & Co. KG

Londorfer Straße 65
35305 Grünberg
Germany

Tel.: +49 6401 807-0
info@bender.de
www.bender.de

Alle Rechte vorbehalten.
Nachdruck und Vervielfältigung nur mit
Genehmigung des Herausgebers.

All rights reserved.
Reprinting and duplicating only with
permission of the publisher.

© Bender GmbH & Co. KG, Germany
Subject to change! The specified
standards take into account the edition
valid until unless otherwise indicated.

