



COMTRAXX® CP9...-I Series

Condition Monitor with display and integrated gateway

Software version V4.6.x



Table of contents

1	General instructions.....	7
1.1	How to use the manual.....	7
1.2	Indication of important instructions and information.....	7
1.3	Signs and symbols.....	7
1.4	Service and Support.....	7
1.5	Training courses and seminars.....	7
1.6	Delivery conditions.....	8
1.7	Inspection, transport and storage.....	8
1.8	Warranty and liability.....	8
1.9	Disposal of Bender devices.....	8
1.10	Safety.....	9
2	Intended use.....	10
3	Product description.....	11
3.1	Scope of delivery.....	11
3.2	Device features.....	11
3.3	Scope of functions CP9...-I (V4.6.0 and higher).....	11
3.4	Applications.....	12
3.5	Function.....	13
3.6	Functional description.....	13
3.6.1	Interfaces.....	13
3.6.2	Process image.....	14
4.1	Mounting.....	15
4.2	Digital inputs.....	23
4.3	Relay.....	23
4.4.1	Address configuration and termination.....	25
4.4.2	Browser configuration.....	25
4.4.3	Software products used.....	25
4	Web user interface.....	26
4.1	Functions of the web user interface.....	26
4.2	Software products used.....	27
4.3	Browser configuration.....	27
4.4	Home page COMTRAXX® user interface.....	27
4.4.1	Headline.....	27

4.4.2	Path display (breadcrumb navigation).....	28
4.4.3	Navigation.....	28
4.4.4	Subnavigation.....	28
4.4.5	Content area.....	29
4.4.6	Overview of pending alarms.....	29
4.5	Making settings on the device.....	29
4.5.1	Digital input.....	29
4.5.2	Relay.....	30
4.5.3	Interface.....	30
4.5.4	Edit texts.....	31
4.5.5	E-mail.....	31
4.5.6	History/Logger.....	32
4.5.7	Clock.....	32
4.5.8	Display.....	33
4.5.9	Password.....	33
4.5.10	Buzzer.....	34
4.5.11	Factory settings.....	34
5	Visualisation.....	35
5.1	The headline.....	35
5.1.1	Drop-down menu 'File'.....	35
5.1.2	Grouping functions.....	36
5.1.3	Project name.....	36
5.1.4	Language selection.....	36
5.1.5	Simulating visualisation.....	36
5.2	The 'work area'.....	37
5.3	Dashboards.....	37
5.4	Widget library.....	37
5.4.1	Widget list.....	38
5.4.2	Placing widgets in the work area.....	41
5.5	Settings.....	41
5.5.1	Project settings.....	42
5.5.2	Widget settings.....	43
5.6	Widget alignment.....	49
5.7	Guides and grid.....	50
5.7.1	Guides.....	50
5.7.2	Grid.....	50
5.8	Used widgets.....	50

6	Virtual devices.....	52
6.1	Application possibilities.....	52
6.2	Managing virtual devices.....	52
6.2.1	Virtual devices: Overview list/Main page.....	52
6.2.2	Editing a virtual device.....	53
6.2.3	Editing channels.....	53
6.2.4	Deleting a device.....	53
6.2.5	Adding a virtual device.....	53
7	PROFINET.....	55
7.1	Configuration of the PROFINET interface.....	55
7.2	Device assignment for PROFINET.....	55
7.3	Data modules.....	55
7.4	Example of a data query.....	57
8	Modbus TCP server.....	58
8.1	Modbus requests.....	58
8.1.1	Example for function code 0x03.....	58
8.1.2	Example for function code 0x04.....	59
8.1.3	Example for function code 0x10.....	59
8.2	Modbus responses.....	60
8.2.1	Responses for function code 0x03 and 0x04.....	60
8.2.2	Responses for function code 0x10.....	60
8.2.3	Exception code.....	61
8.3	Modbus system image.....	61
8.4	Bender Modbus image V1.....	62
8.4.1	Querying data with Modbus function code 0x03.....	62
8.4.2	Querying data with Modbus function code 0x04.....	63
8.4.3	Writing data with Modbus function code 0x10.....	63
8.4.4	Distribution of the memory areas.....	63
8.4.5	Memory scheme of the system image.....	64
8.4.6	Memory scheme of an individual device.....	64
8.4.7	Example: Determine start address.....	64
8.4.8	Data formats.....	66
8.4.9	Modbus example for reading data (V1).....	70
8.4.10	Reference data records of the process image.....	71
8.4.11	Address assignment of the reference data record.....	71
8.4.12	Reference value on channel 1.....	72

8.4.13	Reference value on channel 2.....	72
8.4.14	Explanation of how to access floating point values.....	72
8.5	Bender Modbus image V2.....	73
8.5.1	Function codes (V2).....	73
8.5.2	Distribution of the memory areas (V2).....	74
8.5.3	Memory scheme of the system image (V2).....	75
8.5.4	Memory scheme of a device (V2).....	76
8.5.5	Modbus example for reading data (V2).....	79
8.5.6	Reference data records of the system image (V2).....	79
8.6	Channel descriptions for the process image (V1 and V2).....	80
8.7	Modbus control commands.....	86
8.7.1	Writing to registers.....	86
8.7.2	Reading registers.....	86
8.7.3	Control commands for the (internal/external) BMS bus.....	86
8.7.4	Modbus example for control commands.....	87
9	Modbus RTU Slave.....	89
10	SNMP.....	90
10.1	Data access using SNMP.....	90
10.2	Device assignment for SNMP.....	90
11	Troubleshooting.....	91
11.1	Malfunctions.....	91
11.1.1	What should be checked?.....	91
11.1.2	Frequently asked questions.....	91
11.2	Device operation, maintenance, cleaning.....	91
12	Technical data.....	92
12.1	Tabular data.....	92
12.2	Standards, approvals and certifications.....	99
12.3	Ordering information CP9...-I.....	100
12.4	Document revision history.....	101

1 General instructions

1.1 How to use the manual



ADVICE

This manual is intended for qualified personnel working in electrical engineering and electronics! Part of the device documentation in addition to this manual is the enclosed supplement 'Safety instructions for Bender products'.



ADVICE

Read the operating manual before mounting, connecting and commissioning the device. Keep the manual within easy reach for future reference.

1.2 Indication of important instructions and information



DANGER

Indicates a high risk of danger that will result in death or serious injury if not avoided.



WARNING

Indicates a medium risk of danger that can lead to death or serious injury if not avoided.



CAUTION

Indicates a low-level risk that can result in minor or moderate injury or damage to property if not avoided.



Information can help to optimise the use of the product.

1.3 Signs and symbols



Disposal



Protect from moisture



Protect from dust

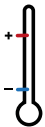

Temperature range



Recycling



RoHS directives

1.4 Service and Support

Information and contact details about customer service, repair service or field service for Bender devices are available on the following website: Fast assistance | Bender GmbH & Co. KG.

1.5 Training courses and seminars

Regular face-to-face or online seminars for customers and other interested parties:

www.bender.de > know-how > seminars.

1.6 Delivery conditions

The conditions of sale and delivery set out by Bender GmbH & Co. KG apply. These can be obtained in printed or electronic format.

The following applies to software products:



'Software clause in respect of the licensing of standard software as part of deliveries, modifications and changes to general delivery conditions for products and services in the electrical industry'

1.7 Inspection, transport and storage

Check the shipping and device packaging for transport damage and scope of delivery. In the event of complaints, the company must be notified immediately, see 'Technical support: Service and support'.

The following must be observed when storing the devices:

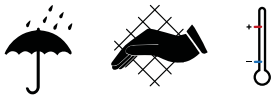

1.8 Warranty and liability

Warranty and liability claims for personal injury and property damage are excluded in the case of:

- Improper use of the device.
- Incorrect mounting, commissioning, operation and maintenance of the device.
- Failure to observe the instructions in this operating manual regarding transport, commissioning, operation and maintenance of the device.
- Unauthorised changes to the device made by parties other than the manufacturer.
- Non-observance of technical data.
- Repairs carried out incorrectly.
- The use of accessories or spare parts that are not provided, approved or recommended by the manufacturer.
- Catastrophes caused by external influences and force majeure.
- Mounting and installation with device combinations not approved or recommended by the manufacturer.

This operating manual and the enclosed safety instructions must be observed by all persons working with the device. Furthermore, the rules and regulations that apply for accident prevention at the place of use must be observed.

1.9 Disposal of Bender devices

Abide by the national regulations and laws governing the disposal of this device.



For more information on the disposal of Bender devices, refer to www.bender.de > service & support.

1.10 Safety

If the device is used outside the Federal Republic of Germany, the applicable local standards and regulations must be complied with. In Europe, the European standard EN 50110 applies.



DANGER *Risk of fatal injury due to electric shock!*

Touching live parts of the system carries the risk of:

- Risk of electrocution due to electric shock
- Damage to the electrical installation
- Destruction of the device

Before installing the device and before working on its connections, make sure that the installation has been de-energised. The rules for working on electrical systems must be observed.

2 Intended use

Condition monitors CP9...-I show alarms, measured values and states of devices. These include, for example:

- All Bender devices with BMS bus or BCOM interface
- Bender devices (PEM, energy meters,...) with Modbus RTU or Modbus TCP interface
- Other devices with Modbus RTU or Modbus TCP interface

In addition, the data is available via the Modbus TCP protocol. This allows coupling to a higher-level building control system as well as visualisation and evaluation using standard web browsers.

Operation and settings are made via the COMTRAXX® user interface integrated in the device.

Any other use than that described in this manual is regarded as improper.

3 Product description

This manual describes

- The COMTRAXX® **CP907-I** condition monitor with display and an integrated gateway
- The COMTRAXX® **CP915-I** condition monitor with display and an integrated gateway

3.1 Scope of delivery

Included within the scope of delivery

- A CP9...-I condition monitor with display
- A printed quick-start guide
- Sicherheitshinweise für Bender-Produkte
- Safety instructions for Bender products
- The manuals 'COMTRAXX® CP9...-I' und 'BCOM' are available as PDF files for download at <https://www.bender.de/en/service-support/download-area/>

For CP915-I additionally

- Connecting cable
- Ethernet-Keystone coupler
- USB cable
- RJ45 flat patch cable

3.2 Device features

- Display sizes 7' and 15.6' with tempered and anti-reflective glass
- Easy to clean and disinfect, degree of protection IP54
- Screwless mounted front plate
- Condition monitor for Bender systems
- Integrated modular gateway between Bender systems and TCP/IP
- Remote access via LAN, WAN or Internet
- Support of devices that are connected to the internal BMS bus, via BCOM, Modbus RTU or Modbus TCP
- Individual visualisation can be generated, which can be viewed via the web browser or on the display
- Silent due to operation without fan
- High-quality display with excellent contrast, high resolution and wide viewing angle
- Possibility of graphical integration of building plans or status displays in photo quality
- Visual and acoustic notification in the event of an alarm

3.3 Scope of functions CP9...-I (V4.6.0 and higher)

- Condition monitor with web interface and display
- Interfaces for the integration of devices
 - Internal BMS bus (max. 150 devices)
 - BCOM (max. 255 devices)
 - Modbus RTU and Modbus TCP (max. 247 devices each)
- Selectable display content
 - System overview with all devices, measured values, parameters and alarms
 - Individually configurable visualisation

- Ethernet interface with 10/100 Mbit/s for remote access via LAN, WAN or Internet
- Time synchronisation for all assigned devices
- History memory (20,000 entries)
- Data logger, freely configurable (30 x 10,000 entries)
- Assignment of individual texts for devices, channels (measuring points) and alarms
- Device failure monitoring
- E-mail notifications to different users in the event of alarms and system errors
- Device documentation**) can be created for any device in the system
- System documentation can be created. It documents all devices in the system at once
- Support of external applications (e.g. visualisation programs or PLCs) via the Modbus TCP and Modbus RTU protocols
- Reading the latest measured values, operating and alarm messages from all assigned devices. Uniform access to all assigned devices via Modbus TCP over an integrated server
- Control commands: Commands can be sent from an external application (e.g. visualisation software or PLC) to BMS devices via Modbus TCP or Modbus RTU.
- Access to alarms and measured values via SNMP protocol (V1, V2c or V3). SNMP traps are supported
- Access via PROFINET to alarms and measured values
- Fast and easy parameter setting of all devices assigned to the gateway via web browser or display
- Device backups can be created and restored for all devices in the system
- Quick and easy-to-create visualisation of the system. Integrated editor provides access to a variety of widgets and functions.
 - Display on up to 50 overview pages, where e.g. room plans can be stored. It is possible to navigate within these pages
 - Access to all measured values that are available in the system
 - Buttons and sliders can be used to send BMS test and reset commands, as well as to control external devices via Modbus TCP
- 100 virtual devices with 16 channels each can be created. There, for example, calculations of several measured values can be carried out and the result can be used in the system as a new measured value
- 1600 data points from third-party devices (via Modbus RTU or Modbus TCP) can be integrated into the system

**) Contains all parameters and measured values related to the device, as well as device information (including serial number and software version).

3.4 Applications

- Monitoring and parameter setting of all Bender products that support communication
- Mounting in the control cabinet door so that all information is immediately visible
- Commissioning and diagnosis of Bender systems
- Remote diagnosis and remote maintenance
- Control stations in all areas
- Monitoring and analysis of data centres

3.5 Function

The COMTRAXX CP9...I series includes a condition monitor and is integrated into the existing IT structure like any Ethernet-capable device. All Bender devices can be connected via the integrated interfaces. In addition, third-party devices can also be integrated into the system. The measured values, parameters and all other data can be checked and parameterised via the web interface. It is possible to report and visualise alarms. The visualisation application can be used to generate individual overview pages, which are then displayed in a web browser.

Verified web browsers: Microsoft Edge, Mozilla Firefox, Google Chrome.

3.6 Functional description

3.6.1 Interfaces

CP9...-I communicate with the devices and systems assigned via various interfaces:

- Internal BMS bus (RS-485) for Bender systems such as EDS46.../49..., RCMS46.../49... and MEDICS®. CP9...-I can be operated as a master or as a slave. When operated as a master, requests are answered more quickly. The devices can only be operated on the internal BMS bus.
- BCOM (Ethernet) for new and future Bender systems, such as ISOMETER® iso685-D.
- Modbus RTU (RS-485) CP9...-I when operated as a master for Bender devices PEM... with restricted functionality (full functionality of PEM...5 only via Modbus TCP).
- Modbus TCP (Ethernet) for Bender devices PEM...5

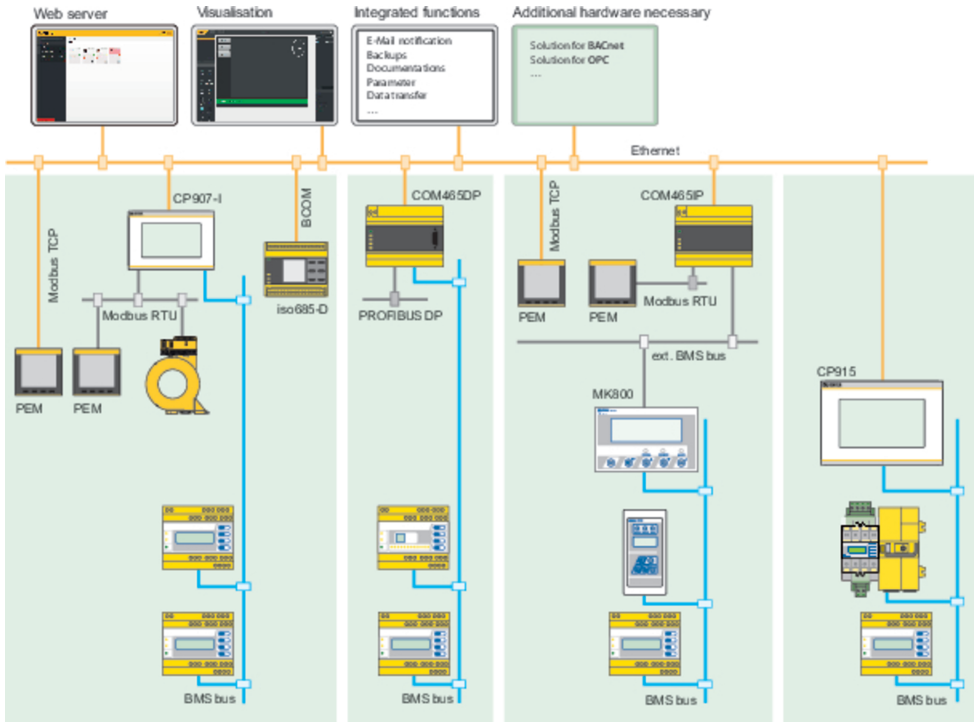

Image 3-1: System overview interfaces CP9...-I

3.6.2 Process image

The CP9...-I prepares and saves a process image from the communication with the devices assigned. This process image contains alarms, status information and measured values from the devices assigned.

The CP9...-I combines the information from the different interfaces and makes it available for:

- Display and configuration via the system overview on the display or web interface
- Display and operation via the visualisation on the display or web interface
- Transmission to external systems via Modbus TCP or SNMP

The CP9...-I provides a common user interface for the devices assigned via different interfaces. On this user interface, each device is given an individual address by which it can be identified. BMS, BCOM and Modbus RTU devices receive the appropriate address for their interface. A virtual address is assigned to Modbus TCP devices so that they can be addressed correctly in the system.



Only **qualified personnel** are permitted to carry out the work necessary to install, commission and run a device or system.



CAUTION
Functional earth

The device must be earthed. Without connection of the functional earth, the device function is not guaranteed.

Electrostatic sensitive components

Observe the precautions for handling electrostatic sensitive devices.

Damage to components

Do not remove the device from the enclosure while it is in operation. Disconnect the device from the supply voltage and from the network (Ethernet) beforehand.

Damage to the device due to incorrect connector plug

Connector plugs of other devices may have different polarity. Make sure to use the supplied connector plug.

Protective separation

The power supply must be properly separated from hazardous voltages and meet the limit values of UL/CSA 61010-1, clause 6.3.

4.1 Mounting

The COMTRAXX® CP9...-I devices are installed

- either in the supplied and professionally pre-assembled flush-mounting enclosures
- or with the optionally available control cabinet door mounting (CP907-I only)
- or in an optionally available surface-mounting enclosure (CP907-I only)

Dimension diagram

		Device dimensions		
		Dimensions (mm) ±1		
Type		a	b	c
CP907-I		226	144	176 (7')
CP915-I		505	350	386 (15,6')

		Installation dimensions enclosure		
		Dimensions (mm)		Required installation depth
Type	Enclosure	a	b	
CP907-I	Flush-mounting	212	124	75
	Door	215	124	65
	Surface-mounting	299	173	---
CP915-I	Flush-mounting	464	309	92
	Surface-mounting	511	356	---

Glass thickness: 3 mm

Mounting CP907-I

Flush-mounting enclosure CP907-I

i **Mounting of flush-mounting enclosures**

The supplied flush-mounting enclosures are only suitable for mounting in cavity walls. In drywall and stud frame constructions, the enclosures must be screwed at right angles to battens or to the stud frame structure. The enclosure must not warp during mounting. The wall surface must be even.

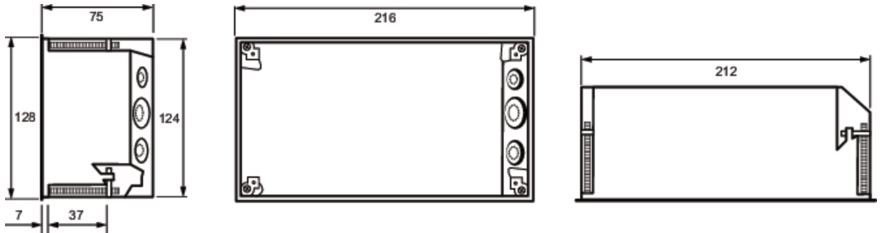

Flush-mounting enclosure CP907-I, dimensions in mm

i **Tightening torque**

The tightening torque for the mounting screws may be in a range between 0.8 ... 1 Nm.

4.1.1.1 Control cabinet door mounting CP907-I

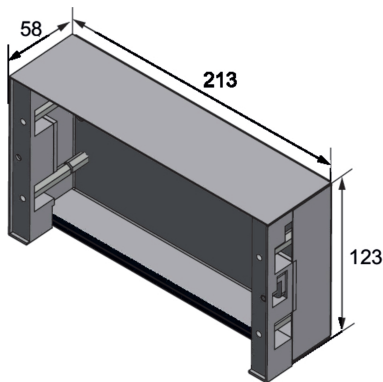

Enclosure for control cabinet door mounting, dimensions in mm

i **Tightening torque**

The tightening torque for the mounting screws may be in a range between 0.8 ... 1 Nm.

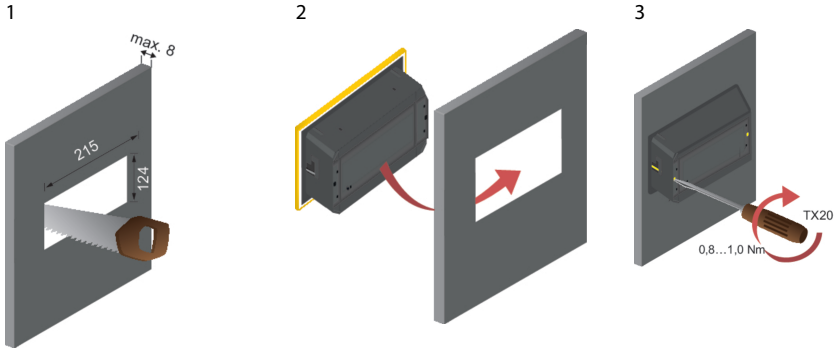

Control cabinet door mounting, dimensions in mm

Surface-mounting enclosure CP907-I

For surface mounting, the flush-mounting enclosure is mounted in the optionally available surface-mounting enclosure (B95061915).

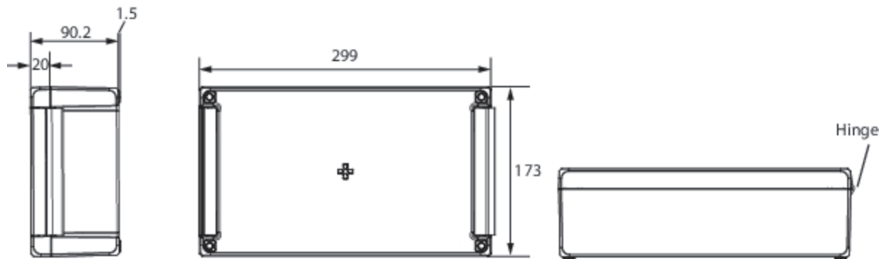

Enclosure for surface mounting CP907-I, dimensions in mm

Mounting procedure:

1. Assemble surface-mounting enclosure (fit hinges and bracket).
2. Insert the flush-mounting enclosure through the opening in the cover. Mount the enclosed plastic frame from behind and screw it in place using the fasteners of the flush-mounting enclosure.
3. Make the required cable openings in both enclosures.
4. Connect the CP907-I and mount it in the enclosure.

Mounting CP915-I

Flush-mounting enclosure CP915-I



Mounting of flush-mounting enclosures

The supplied flush-mounting enclosures are only suitable for mounting in cavity walls. In drywall and stud frame constructions, the enclosures must be screwed at right angles to battens or to the stud frame structure. The enclosure must not warp during mounting. The wall surface must be even.

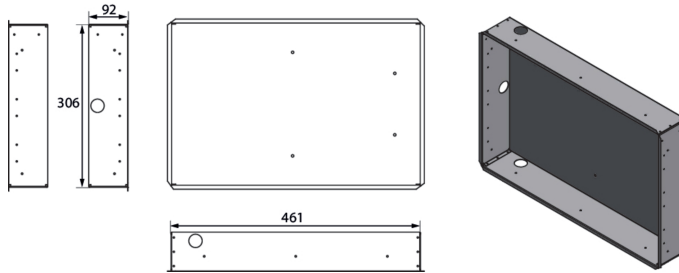

Flush-mounting enclosure CP915-I, dimensions in mm

Surface-mounting enclosure CP915-I

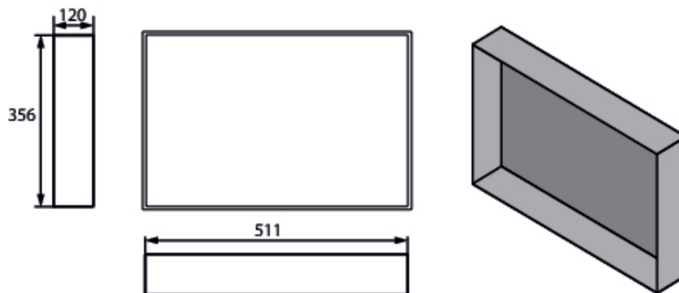

Surface-mounting enclosure CP915-I, dimensions in mm

Removing the CP915-I front plate

The front plate is removed from the enclosures of the CP915-I devices using a suction lifter. For this purpose, the suction lifter must be placed on the points marked below one after the other and the front plate must be removed until it clicks into place for the first time. If the front plate is detached on both sides, the plate can be lifted off the enclosure.



CAUTION *Damage to the display front*

Placing the suction lifter in the middle and pulling only at this point may damage the front plate. Always place the suction lifter on the edges of the display.



Connection of the CP9...-I device

The CP9...-I is integrated into existing LAN structures, but can also be operated via a single PC.

i **Configuration of computer networks**
 If you are familiar with the configuration of computer networks, you can carry out the connection of the device yourself. **Otherwise please contact your IT administrator!**

i **Ethernet**
 The shield of the Ethernet cable must be connected to PE on both sides.

i **For UL applications (CP907-I only)**
 Use copper lines only. Minimum temperature range of the wires to be connected to the plug-in terminals: 75 °C.

i **PoE (CP907-I only)**
 Minimum temperature range of the cables (copper lines) to be connected to the PoE Ethernet connection: 80 °C

For operation via PoE, the voltage transmitter (router) must meet one of the following requirements:

- Class 2 requirement acc. to UL1310 or
- Limited power source requirement acc. to UL 60950 or
- Limited energy circuit requirement acc. to UL 61010.

In case of a pure PoE supply, no supply of the I²C expansion modules is possible. Maximum cable length I²C < 3 m

Remove the CP9...-I from the built-in flush-mounting enclosure.

Mainboard and connections of the CP9...-I device

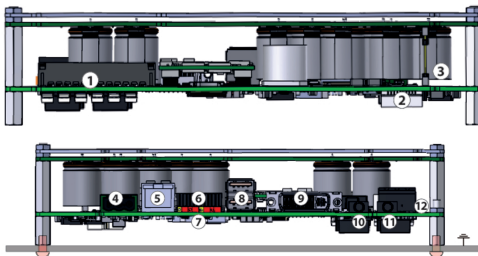

No.	Connection	CP907-I	CP915-I
1	Plug connector digital inputs		
2	I ² C interface		
3	Plug connector to energy storage board		
4	Voltage supply A1/+, A2/-, PE		
5	Ethernet (RJ45/CAT5); HTTP, Modbus TCP, BCOM	with PoE	without PoE
6	X1 plug connector for Modbus RTU, BMS bus		
7	Termination of Modbus RTU and BMS bus		
8	USB ports (for touch sensor)	not included	
9	DVI output	not included	
10	Audio output	not included	
11	Audio input	not included	
12	Connection to control relay		

Connect the device as follows:

1. Modbus RTU connection (6): Connect terminals **AMB** and **BMB** to the Modbus RTU (A to A, B to B).
2. BMS bus connection (6): Connect terminals **ABMS** and **BBMS** to the BMS bus (A to A, B to B)

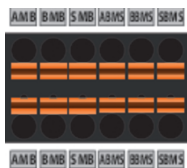

X1 plug assignment (6)

3. If the CP9...-I is located at the beginning or end of the respective bus (Modbus RTU and BMS), the respective terminating switch of the device (7) must be switched to 'ON'.

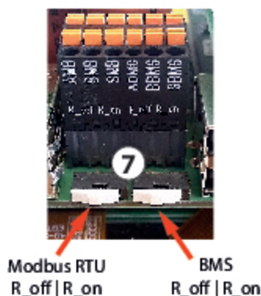

4. Establish connection with PC and BCOM: Connect the CP9...-I device to the PC network using an Ethernet cable (5).
5. Link digital inputs.
See chapter Digital inputs.
6. Connect relay (if necessary).
See chapter Relay
7. Connect the power supply.

**CAUTION****Functional earth**

The device must be earthed. Without connection of the functional earth, the device function is not guaranteed.

Electrostatic sensitive components

Observe the precautions for handling electrostatic sensitive devices.

Damage to components

Do not remove the device from the enclosure while it is in operation. Disconnect the device from the supply voltage and from the network (Ethernet) beforehand.

Damage to the device due to incorrect connector plug

Connector plugs of other devices may have different polarity. Make sure to use the supplied connector plug.

Protective separation

The power supply must be properly separated from hazardous voltages and meet the limit values of UL/CSA 61010-1, clause 6.3.

Connect terminals A1/+ and A2/- (4) to the power source. Connect PE to earth. The CP907-I can also be supplied via Power-over-Ethernet (PoE). **The PoE switch must be earthed.** For further details, see technical data.

8. Attach the front plate to the built-in flush-mounting enclosure.

CP907-I is mounted. The following steps apply to CP915-I only:

9. Connect the front panel to the control board and the power supply:
Connect a USB socket **(8)** to the touch sensor connector on the front panel. Associated connection cable included in the scope of delivery.

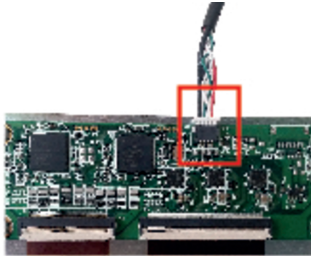

10. Connect the screen output DVI **(9)** to the front plate. DVI cable: Cable length < 3 m, connect firmly to PE on both sides.

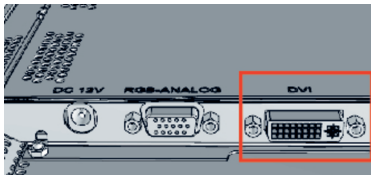

11. When using the audio output **(10)**, an electrically isolated amplifier must be used.
12. Connect the voltage supply to the power supply unit via the pre-assembled wiring. Connect the earthing to the front plate.

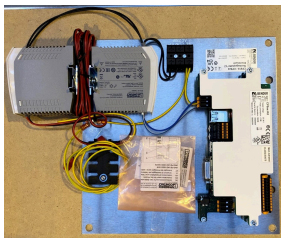

Pre-assembled voltage supply

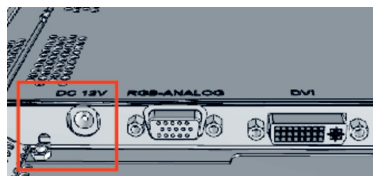

Connection earthing on front plate



The dual power supply unit supplies the CP915 with 24 V and the display with 12 V.

13. Attach the front plate to the built-in flush-mounting enclosure.

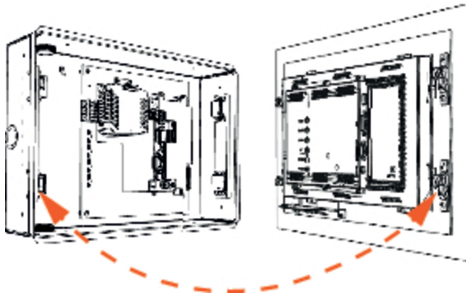

4.2 Digital inputs

CP9...-I devices feature 12 configurable digital inputs. Settings are made via the COMTRAXX® user interface in a browser (see chapter Digital input).

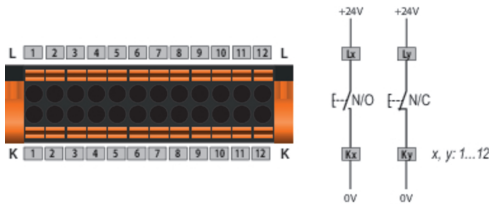

Function

The following functions can be assigned to the digital inputs:

- off Digital input without function
- TEST Self test of the device
- RESET Reset fault and alarm messages

4.3 Relay

The relay parameters are set in the device menu (see chapter Relay).

Connection relay

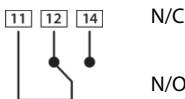

- N/C** operation contacts **11-12**
(the alarm relay is energised during normal operation).
- N/O** operation contacts **11-14**
(the alarm relay is de-energised during normal operation).

Commissioning of the CP9...-I device

1. Switch on the supply voltage:
After switching on, the device performs a start routine. It is completed when the commissioning page appears on the display.

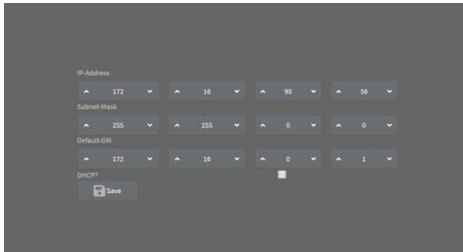

2. Enter the desired IP address in the 1st line
3. Enter the subnet mask in the 2nd line
4. Enter the address of the default gateway.
5. Press the 'Save' button to store the entries.
6. Wait 8...10 seconds. The COMTRAXX[®] system overview starts.
7. If there is a DHCP server in the network, select only the check box to the right of the 'DHCP?' label in line 4. Confirm your selection by pressing the 'Save' button. The network settings transmitted from the server are shown on the display after 8...10 seconds.



After this, the commissioning must be continued via the COMTRAXX[®] user interface.

Factory settings communication addresses

Parameter	Factory setting
IP address	-
IP address for 1:1 ETH conn.	169.254.0.1
Net mask	255.255.0.0
Standard gateway	192.168.0.1
DNS	-
DHCP	aus
t_{off} Timeout for address assignment	30 s
BMS address	1
BMS protocol	BMS i
BCOM system name	SYSTEM

Parameter	Factory setting
Subsystem address	1
BCOM device address	0

The settings can be changed during commissioning via the display or the web user interface.

- From an external application (e.g. visualisation software), commands can be sent to BMS devices. The 'Modbus control commands' menu provides Modbus control commands for selected BMS commands. These commands can be copied to the clipboard of the PC and then included in the programming of the external application.
- Graphical display with scaling of the time axis for the data loggers of the gateway and compatible Bender devices.

BMS interface

The majority of Bender devices communicate via the internal BMS bus. CP9...-I can be operated as a master or as a slave.



CP9...-I is to be operated as a master if:

- Parameters are queried or changed
- Certain control commands are issued

Note that not all BMS masters can surrender their master function!

4.4.1 Address configuration and termination

To ensure proper functioning of the CP9...-I, correct address assignment and termination is of utmost importance.



Multiple assignment of addresses

The factory setting for the system name on all Bender BCOM devices is 'SYSTEM'. If several systems with the same system name are integrated into the same network, addresses are assigned twice. This leads to transmission errors. Always enter a unique BCOM system name during initial configuration.

4.4.2 Browser configuration

The latest version of Google Chrome, Microsoft Edge or Mozilla Firefox is recommended.

4.4.3 Software products used

Select  **Tools > Information > Copyright**, to display the used software products.

4 Web user interface

The web user interface of the device enables access via LAN, WLAN or the Internet. It provides a uniform display of Bender devices that are connected to:

- The internal BMS bus
- BCOM
- Modbus RTU
- Modbus TCP

Each interface has its own address range. Each device is given its own individual address by which it can be identified.

4.1 Functions of the web user interface

- Bus overview of the associated devices
 - Indicating alarms and measured values
 - Display by interface or subsystem
 - Setting, displaying and evaluating the history memory and data loggers
 - Graphical display of measured values (bar graph, phasor diagram, power triangle) and waveform recorders; in case of universal measuring devices, additional display of the harmonics as table or bar graph
 - Setting device parameters
 - Device failure monitoring
 - Saving settings as 'backup' and restoring values again
 - Documenting settings and measured values
 - Assigning individual texts for devices, measuring points (channels) and alarms
 - E-mail notifications to different user groups according to a time-controlled schedule in the event of alarms and system errors. The sender's e-mail address can be entered.
 - Display of virtual devices. A virtual 'measuring point' is obtained by logically or numerically evaluating measured values of 'real' devices connected to the gateway.
- Management of Modbus devices
 - Adding/deleting devices to/from the bus overview
 - Creating a template with selected measured values
- Visualisation
 - Fast, simple visualisation can be configured in its own editor without programming knowledge
 - Measured values, alarms, buttons, etc. can be arranged and displayed in front of a graphic (system diagram, room plan) using various widgets
 - Displaying an overview page; jumping to another view page and back to the overview page is possible
- From an external application (e.g. visualisation software), commands can be sent to BMS devices. The 'Modbus control commands' menu provides Modbus control commands for selected BMS commands. These commands can be copied to the clipboard of the PC and then included in the programming of the external application.
- Graphical display with scaling of the time axis for the data loggers of the gateway and compatible Bender devices.

4.2 Software products used

Select **Tools** > **Information** > **Copyright** to display the used software products.

4.3 Browser configuration

As browser, the latest version of Google Chrome, Microsoft Edge and Mozilla Firefox are recommended. To use the functions of the web user interface, JavaScript has to be activated. The pop-up blocker should be deactivated for the IP address of the COMTRAXX® device.

For Windows® Internet Explorer, the compatibility view has to be disabled.
Select **Extras** > **Configuration of compatibility view**. **Deactivate** the button **Display Intranet sites in compatibility view**.

4.4 Home page COMTRAXX® user interface

1. Open an Internet browser.
2. Enter the IP address of the gateway in the address line (example: http://172.16.60.72).

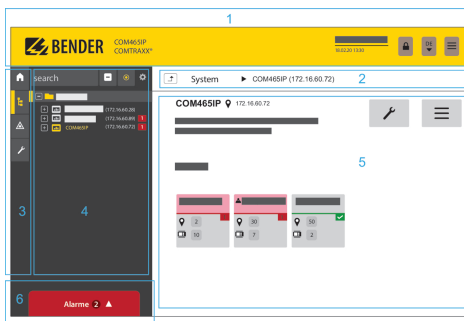

- 1 Headline
- 2 Path display
- 3 Navigation
- 4 Subnavigation
- 5 Content area
- 6 Alarm overview

4.4.1 Headline



- 1 Clicking the logo: Return to home page
- 2 Used device: Device type
- 3 Used device: **System name** > **Subsystem** > **Device address**
Date and time of the device
- 4 The symbol indicates that the web user interface is protected by a password. Click the symbol and then click **Login** to enter the user name and password.
- 5 Language selection
- 6 Open/close navigation (button only available in small browser window)





4.4.2 Path display (breadcrumb navigation)



1= Device

The path display shows at any time on which device and in which bus you are currently located in the content window.

4.4.3 Navigation

	Menu	Description
	Start	Display of information about the device and the software. Please have this information to hand if you need to contact us for assistance by telephone.
	System overview	The system overview shows all devices in the system either by subsystem or by interface. Pending alarms and operating messages are displayed and the respective devices can also be configured.
	Alarms	Display of all pending alarms and data of the devices sending an alarm
	Tools	Functions that affect the entire system

The navigation symbols are permanently visible on the left side. Even if a random submenu of the web user interface is open, you can navigate to one of the four areas by clicking the respective symbol.

4.4.4 Subnavigation

The system overview is displayed in the subnavigation.



Legend

1. Full text search in the system for device names or menu entries. Matches are highlighted in yellow.
2. Close unfolded tree in the subnavigation
3. Fold out automatically: When enabled (= yellow), the displayed contents of the content area are shown in the subnavigation with automatically unfolding device tree in addition to the path display. Path display and content area are always synchronous. When disabled (= white), the subnavigation is not adapted to the path display or the current content area.

- 4. - Select **display** by subsystems or by interfaces. The interface display is only available for COMTRAXX® V4.xx and higher.
 - Configure the **line height** of the entries.
- 5. The number in brackets (here: 25) indicates the set bus address.

i *The display by subsystem or interface is possible independently of the configured Modbus image V1 or V2.*

4.4.5 Content area

Display of the system, alarms and entries for the tools .

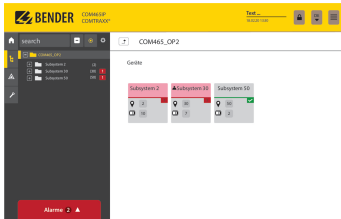

Content area of the system display by **subsystem**

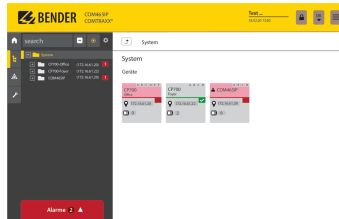

Content area of the system display by **interface**

4.4.6 Overview of pending alarms



i *Clicking the alarm overview: List of pending alarms*
Clicking on the list: Details about the alarms in the content area

4.5 Making settings on the device

Changes must be saved before leaving the respective mask. Otherwise they are discarded.

4.5.1 Digital input

Menu > Settings > Digital input 1 - 12

For each of the 12 digital inputs DI1...12, the following can be defined:

Parameter	Options/Setting range
Mode	High-active Low-active Impuls (High-active) Impuls (Low-active)
Measurement type	Operating message Alarm Error(s)

Parameter	Options/Setting range	
t_{on}	Response delay	0 s ... 10 minutes
t_{off}	Switch-off delay	

An event is executed when the digital input experiences an edge change. The edge change must be present at least for the set response delay t_{on} , otherwise it is ignored.

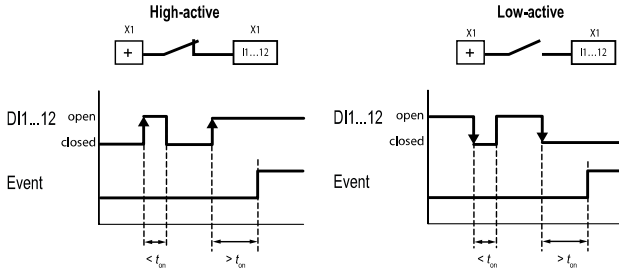

4.5.2 Relay

Menu > Settings > Relay

Setting options	Options	Explanation
Relay mode	N/O	Normally Open
	N/C	Normally Closed
Relay mode	Cont.	Relay remains permanently energised.
	Imp.	Relay is energised for one pulse.
	Flash	Relay switches several times between active and inactive.
Timer	100 ms ... 2 s	'Imp.' mode: impulse time 'Flash' mode: cycle time
PowerOn	off	Relay is deenergised during device start.
	on	Relay is energised during device start.
	PowerOff	During device start the relay takes on the same state it had when the supply voltage was switched off.

4.5.3 Interface

Menu > Settings > Interface

The required parameters for each connected interface are set here:

- Ethernet
- BMS
- Modbus

- SNMP
- PROFINET
- POWERSCOUT®

4.5.4 Edit texts

Menu > Settings > Edit texts

The individual device and channel texts of the COMTRAXX® device are configured here. The data logger texts can also be edited.

Setting options	Setting for.../Description	
Channels	DI1...12	Descriptive text and alarm text
	DO1	Descriptive text and alarm text
	Timer 1...12	Descriptive text
Device	Device name	
	Message in case of device failure	
Data logger	Data logger1...30	Descriptive text

4.5.5 E-mail

Menu > Settings > E-mail > Profile

The following is set for 5 different profiles:

Setting options	Setting for.../Description
Settings	Profile Active Server Timeout Port Encryption Check certificate User Password
E-mail	Language Sender To (= addressee) Subject Messenger header Message footer E-mail in the event of prewarning E-mail in the event of test alarm System monitoring
Test	Send test e-mail to check all settings

4.5.6 History/Logger

Menu > Settings > History/Logger

Setting options	Setting for.../Description	
History	History content	Complete system
		Own device and all subdevices
	Delete	
Data logger 1...30	Name	
	Path	
	Status	on, off
	Percentage change	off, 1...99 %
	Trigger	off, 15 minutes ...7 days
	Absolute change	off or precise limit value
	Overwrite	yes, no
	Delete	
BMS recording		off, 1...7 days

4.5.7 Clock

Menu > Settings > Clock

Setting options	Setting for.../Description
Summer time	off, on, CEST, DST
UTC offset	
NTP	off, on
NTP server	

4.5.8 Display

Menu > Settings > Display

Setting options	Setting for.../Description	
Display	Resolution	
	Rotation	Observe mounting direction of display
Standard view	Standard view	System overview ¹⁾ , visualisation, IP address
	Return to standard view	off, 1...30 min
	Allow switching from system overview to visualisation ²⁾	on, off

- 1) The system overview known from the web application can also be shown on the display. This allows alarms and details to be displayed or settings to be made directly on the device. The system overview is configured as the default display at the factory and is shown during device start.
- 2) *Prerequisite: A visualisation has been created.*
If 'Allow switching from system overview to visualisation' is enabled in the settings, a button for switching to the visualisation appears on the display. To return from the visualisation to the system overview, the widget  must be placed and configured in the visualisation. This allows you to switch between the visualisation and the system overview at any time.

4.5.9 Password

Menu > Settings > Password

The password protection is configured in the device menu of the respective COMTRAXX® device. Password protection can be configured for the roles **User** and **Administrator**. This allows regulating the access to the web user interface.



CAUTION

Risk of damage to equipment due to unauthorised access

The password protection for the gateway protects against unauthorised access to a limited extent only. Attackers from the Internet may still be able to read data and change settings.

It is absolutely necessary that:

- *The network is separated from the Internet.*
- *Common security mechanisms are applied (firewall, VPN access).*

The default user names and authorisations ('admin, read and write' and 'user, read only') cannot be changed

Setting options for role	Setting for.../Description
Status	enabled, disabled
Password	A...Z a...z 0...9 - _

4.5.10 Buzzer

Menu > Settings > Buzzer

- Volume (High, Normal, Low)

4.5.11 Factory settings

Menu > Settings > Factory setting

When resetting to factory settings, all settings, parameters, data logger and history memory are reset. It can be specified that Ethernet settings are not affected.

5 Visualisation

The data from the Bender system can be displayed in a separate visualisation. It provides access to all measuring channel information, alarms and other data. The application is shown in a separate browser tab of the connected device and does not require any further plug-ins. The visualisation is configured in an editor. The editor is accessed via the menu item

 **Tools > Visualisation > Edit**

in the COMTRAXX® application. The user interface is illustrated schematically in the graphic below.

Browser tab		
Headline		
Dashboards	'Work area'	Settings
Widget library		
		Used widgets

The 'work area' represents the visible area in the browser tab. Individual elements with different functions, so-called **widgets**, are placed on it to form a 'picture' called 'Dashboard'. Up to 50 different dashboards can be created and linked to each other. All the dashboards organised in an interconnection are grouped together as a 'project' and can be saved on the PC or transferred to the device.

The created visualisation can then be started in a separate browser tab in the COMTRAXX® application via the menu items  **Tools > Visualisation > Displays**.

The following section describes the buttons, tools and elements available in the editor.

5.1 The headline

File ▼			Project name	English ▼	
--------	---	---	--------------	-----------	--

5.1.1 Drop-down menu 'File'





File ▼

New project	Create a new project
New dashboard	Create a new dashboard
Import project from PC (Ctrl+O)	Import existing project from PC
Import active project from device (Ctrl+L)	Import current project from the device to PC
Export project to PC (Ctrl+Shift+S)	Export created project to PC

Save and export to device (Ctrl+S)	Save changes and export to device
------------------------------------	-----------------------------------

i *Saving and exporting projects*
 Please note that only the visualisation is saved! The configuration of interfaces, link variables and links is stored in a separate backup file. This is done in the COMTRAXX® application. Select the used device in the bus overview:
Device settings > Export backup.
 This backup contains all configurations made in the COMTRAXX® application, such as link variables, alarm addresses, etc.

5.1.2 Grouping functions

	No widgets selected
	Group selected widgets. Individual widgets can then only be moved in groups.
	No group selected
	Selected group is ungrouped. The widgets can then be edited individually.

5.1.3 Project name

Display of the project name.

5.1.4 Language selection

Select the operating language of the editor. This is not necessarily the language of the automatically generated messages displayed on the device (= export language).

Czech	German	Greek	English GB	English US
Spanish	Finnish	French	Hebrew	Croatian
Hungarian	Indonesian	Italian	Japanese	Sanskrit
Dutch	Norwegian	Polish	Portuguese PO	Portuguese BR
Russian	Slovenian	Serbian	Swedish	Chinese
Turkish				

5.1.5 Simulating visualisation







Simulate the project in a browser tab to test the appearance and functionality of the buttons in advance.

5.2 The 'work area'

The 'work area' represents the display of the visualisation. The widgets can be moved from the widget library to the work area using drag & drop. It only represents a preview of the expected display. The functionality (e.g. navigation) can be tested in the browser after saving the project.

5.3 Dashboards

2/50	Number of created dashboards
	Home page
	Delete dashboard
	Password protected dashboard
	Create a new dashboard



Function

Display and manage existing dashboards and add new dashboards.

A dashboard is a page that can be displayed in the visualisation. Up to 50 different pages (dashboards) can be created. To link the individual dashboards, navigation elements must be placed on the pages.

If several dashboards have been defined, one of the dashboards acts as home page. It is marked with a house icon. This dashboard appears as the starting point after executing the visualisation. The home page assignment is described in the project settings in chapter Project settings.

The active dashboard is highlighted in yellow.

Project	Selection	Alignment	Explanation
Dashboard 'dashboard3'			In the ' Selection ' tab (right side) the dashboard can be named and also password protected ('Protected' yes/no). Password-protected dashboards are marked with a lock symbol in the dashboard list.
General			
Name			
Protected	yes/no		
Password 			

5.4 Widget library

A widget is a template for a defined function to which various values (parameters) can be assigned. This allows both specific values to be transmitted to specific addresses and values from linked systems to be evaluated and displayed.

All available widgets are included in a library.



Use the scroll bar (right) to navigate to further widgets.

When moving the mouse pointer over a widget in the widget library (mouseover), the icons (i and +) with two functions appear at the bottom of the widget.

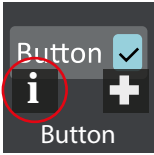

Information on the selected widget

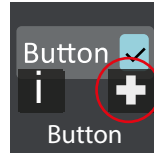













Place selected widget on the top left of the work area









To place a widget on the work area, it can also be dragged there with the mouse see chapter Placing widgets in the work area.

The widget settings are made on the right side in the 'Settings' area. The assignment of values to a widget is described in the chapter Widget settings.

5.4.1 Widget list

Icon	Labelling	Explanation
	Alarm Bar	<i>Alarm overview</i> Display alarm messages in an alarm line. Settings are made at 'Alarm addresses' in the COMTRAXX® user interface in the browser. If several alarm messages are pending, the alarms are displayed one after another. The alarm is always displayed with the background colour set for the most important alarm.
	Background area	<i>Display frame</i> Display a frame with a background colour (optionally with shading).
	Button	<i>Switch with state display</i> The current state can be displayed additionally (optional).
	Cleaning Mode	<i>Lock display operation for a short time</i> Screen lock for cleaning purposes.
	Clock	<i>Display time</i> Display a digital or analogue clock.
	CurrentState/ TargetState	<i>Display current value and target value</i> The target value can be adjusted via the buttons. For control devices that trigger certain events when a target value is reached.
	Dashboard Link	<i>Navigation between existing dashboards</i> Enable switching between dashboards.

Icon	Labelling	Explanation
	Feedback	<i>Display state</i> Colour indication of a value (True or False; ON or OFF).
	Group	<i>Group elements in a frame</i> Display a frame with heading.
	iFrame	<i>Display another website</i> Display the content of a URL in a frame of a freely definable size.
	Image	<i>Display a graphic</i> Place image contents from files. Set level = 0 for background images. Higher levels may overlap other widgets.
	Info	<i>Device information</i> Tabular display of address information
	Label	<i>Create label</i> Display a text field
	Link	<i>Link to another dashboard</i> Link dashboards. The target is the dashboard to which the user wants to switch.
	Logger Table	<i>History memory</i> Display the history memory content of the device. The content to be displayed can be configured.
	Measurement	<i>Display measured value</i> Display the measured value of a channel of a connected device.
	Multiple Images	<i>Display multiple graphics</i> Display different pictures, which are shown depending on the current input value.
	Multiple Labels	<i>Display multiple labels</i> Display different labels, which are shown depending on the current input value.
	Multiple Value Write	<i>Write multiple predefined values</i> Defined values are sent to a defined address.

Icon	Labelling	Explanation
	RGB Color Picker	<i>Colour picker window</i> Range of 16.7 million colours. Provides an RGB colour value.
	RGB-Display	<i>Display frame</i> Display a frame with a background colour (optionally with shading).
	Single Value Write	<i>Write a predefined value</i> Send a set value to a defined address.
	Slider	<i>Slider with state display</i> Slider with optionally available state display.
	Start Test	<i>Start device test</i> Device tests can be started.
	Switch to System overview	<i>Switch to system overview</i> Switch directly to the system overview from any page.
	Timer	<i>Timer function</i> Display of a configurable timer.
	Up/Down Button	<i>Button with two programmable functions and status display</i> Control of equipment (lamp, temperature, shutter...). The current value can optionally be displayed.

5.4.2 Placing widgets in the work area

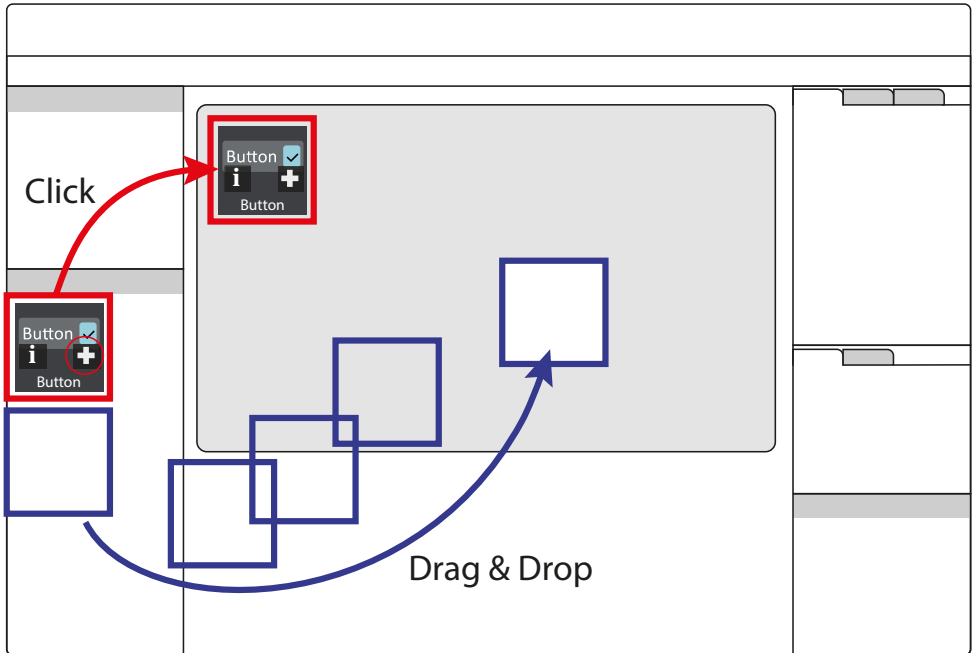

Clicking on the **+** icon of an active widget in the widget library inserts it into the upper left corner of the work area.

The widget can also be placed directly and freely on the work area with the mouse using 'drag & drop'.

5.5 Settings

Settings project

Project	Selection	Alignment
General		
Name	Project 1 CP9xx	
Dashboard width	800	
Dashboard height	480	
Export language	English	
Style	theme-dark	

Widget(s) settings

Project		Selection		Alignment	
Position and size					
X	5	Y	10		
Width	275	Height	50		
	3		0		
General					
Name			Widget name		

All value-based settings are made in the settings area. The values displayed there always represent the values of the currently active element. Elements can be both dashboards and widgets. If multiple widgets are selected, value changes always affect **all** of them. This also applies to grouped widgets. Number and type of parameters vary depending on the widget.

Use the scroll bar (right) to navigate to the setting options hidden in the monitor view.

5.5.1 Project settings

Make individual project settings here.

Project	Selection	Alignment	Explanation
Miscellaneous			
Start	Home		Set home page (dashboard list house icon)
Return to start page after time (min)	5		Time after which the system jumps back in case of inactivity ; only relevant if return to home page is enabled .
Jump to start page	<input type="checkbox"/>		Automatic return to start page ON/OFF
General			
Name	Project 1 CP9xx		Project name in the title bar
Dashboard width (px)	800		Dashboard dimensions in pixels (the dimensions should be based on the size of the visualisation to be configured)
Dashboard height (px)	480		
Export language	English		Language of the channel descriptions (may differ from editor language)
Style	theme-dark		Appearance of the operating elements (buttons)
Relative export	<input type="checkbox"/>		Scaling of the work area to the size of the target medium

Font			
Font colour	#000000		Font colour #RRGGBB with numerical and interactive colour selection Font settings (weight, slant and size)
regular	normal	100	Font settings (weight, slant and size)

i **Font colour selection**
 Numerical input using 6-digit hexadecimal value with leading number sign (hashtag). Colour values are formed as follows: # RR GG BB
 R = red value; G = green value; B = blue value

5.5.2 Widget settings







































Individual widget settings can be made here. Depending on the selected widget, the corresponding setting options are available. The number and type of parameters displayed vary depending on the active widget. In the following, the possible parameter areas are described independently.

5.5.2.1 Predefined icon symbols and units

Icon symbols

One of 45 predefined icons can be selected from a selection menu. After selection, it is displayed on the left side of the respective widget.

Overview icon symbols

	BPS		Radiation		Attention		Settings
	Temperature		OT light		Ventilation		ON/OFF
	IPS		OT light		Humidity		System
	Gas		LED		Rollo		Cleaning
	History		PLC		UPS		Emergency light
	In use		Warning		Room		Half-brightl
	Laser		Intercom		Overview		Bright
	Save set		Plus		Minus		Field size
	Freeze		Half brightness		Field		Brightness
	Synchronisation		Load set				

It is possible to add custom icons at **File > Manage icon library**.



Units

Overview units (predefined)

Ω	Ohm	A	Ampere	V	Volt	%	Percent
Hz	Hertz	Baud	Baud (data rate)	F	Farad	H	Henry
°C	Degree Celsius	°F	Degree Fahrenheit	s	Second	min	Minute
h	Hour	d	day	mo	Month	W	Watt
var	Volt-ampere react.	VA	Volt-ampere	Wh	Watt-hours	varh	Volt-ampere-hours react.
VAh	Volt-ampere-hours	°	Degree	Hz/s	Hertz/second	bar	Bar

5.5.2.2 'General' area

The 'General' area contains parameters which apply to all widgets. Labelled widgets have the additional parameter 'Label'.

Project	Selection	Alignment		Explanation
Position and size				
X	5	Y	10	Position on the work area (in pixels) Default position in the work area is top/left
Width	275	Height	50	Widget dimensions (in pixels)
	3		0	Position on the z level and angle of rotation
General				
Name	Widget name			Assigned automatically or by user
Label	Labelling			Labelling widgets in the work area
Global	<input type="checkbox"/>			Placing the widgets on all dashboards ON/OFF
Locked	<input type="checkbox"/>			Locking the widget ON/OFF
Two writing targets				Enable value transfer to two digital outputs (for 'Up/Down Button' widget)







5.5.2.3 'Action' area

Project	Selection	Alignment	Explanation
Action			
Action	push		For 'Button' widget

5.5.2.4 'Miscellaneous' area

Project	Selection	Alignment	Explanation
Miscellaneous			
Target			Select link destination from existing dashboards
URL			For 'iFrame' widget
Step size	1		
Minimum	0		Only for 'Current state/Target state' and 'Up/Down Button' widgets: Set limits and step size
Maximum	100		
Cont.	20		For 'Cleaning Mode' widget in s

5.5.2.5 'Communication' area

Project	Selection	Alignment	Explanation
Communication			
Endpoint to deactivate			This function can be disabled. The source that does this is assigned here.
Target / Source / Value			Setting options depend on the widget
Connections			
+		Add connection	Add new link
Write in the other direction by pressing and holding	<input checked="" type="checkbox"/>		When enabled, values can also be written back to a source by pressing and holding the button.
relative/absolute	<input checked="" type="checkbox"/>		Widgets „RGB Colour Picker“ und „RGB Display“: relative: 0...100 % absolute: 0...255
red			
green			
blue			
Test group ¹		Group 1	¹ For 'Start Test' widget
Current value ²			² For 'Current State/Target State' widget

i **Colour selection**

Numerical input using 8-digit hexadecimal value with leading number sign (hashtag). Colour values are formed as follows: **#RR GG BB TT**

R = red value; G = green value; B = blue value; T = transparency

5.5.2.6 'Appearance' area

Project	Selection	Alignment	Explanation
Appearance			
Icon	- Icon -		For selection options, see table Icon symbols
Style	Normal		Normal, Dashboard, Transparent, Tab Menu
Alignment			Alignment of the labelling on the element
Unit			For selection options, see table Units
Number of fractional digits	2		Set indication accuracy
Remove trailing zeros			2.70000 is displayed as 2.7
Labels ¹			¹ For the 'Label' and 'Multiple Labels' widgets
Add label			Add an additional line
Default value	default		Standard labelling
Image(s) ²			² For the 'Image', 'Multiple Images' and 'RGB Color Picker' widgets
Add image			Select an image source
Default value	default.png		Standard image
Maintain aspect ratio ²			Maintain aspect ratio YES/NO
Set the size of the alarm groups automatically ³			³ For the 'Alarm Bar' widget
red ⁴			⁴ For the 'RGB Display' widget
green ⁴			
blue ⁴			
Font ⁵	Normal		⁵ For the 'Timer' widget

'Logger Table appearance' area

Project	Selection	Alignment	Explanation
Appearance			
Column name	Width	Visibility	
No.	70	<input checked="" type="checkbox"/>	Number of the record
Timestamp	150	<input checked="" type="checkbox"/>	Timestamp of the record
Path	250	<input checked="" type="checkbox"/>	Path of the measuring point
Type	150	<input checked="" type="checkbox"/>	Type of record (Alarm start, Alarm end, Device restart, Acknowledge, ...)
Start/Min	150	<input checked="" type="checkbox"/>	Value at occurrence of the alarm
Max.	15	<input checked="" type="checkbox"/>	Maximum value for the duration of an alarm (only for 'Alarm end')
Description	150	<input checked="" type="checkbox"/>	Description of the measuring point
Alarm	70	<input checked="" type="checkbox"/>	Type of alarm
Test	150	<input checked="" type="checkbox"/>	Entry initiated by test

The order of the columns cannot be changed. The width (pixels) of the displayed columns can be changed to any value using the arrow buttons in steps of 10 or in the number field. If a column is not needed, it can be hidden by unchecking the box.

If the path specification is longer than the space available in the column, the text is always cut off on the left. This way, the relevant information remains visible.

'Clock appearance' area

Project	Selection	Alignment	Explanation
Appearance			
Mode	Analog ^{1/2}		Mode
Colour	#000000ff		Numerical or interactive colour specification
Show hour marker ¹	<input type="checkbox"/>		Hour marker ON/OFF
Show seconds ¹	<input type="checkbox"/>		Seconds ON/OFF
Show date ²	<input type="checkbox"/>		Display date ON/OFF
Show time ²	<input type="checkbox"/>		Display time ON/OFF

Show seconds ²	<input type="checkbox"/>	Display seconds ON/OFF
---------------------------	--------------------------	------------------------

- 1 Analogue mode
- 2 Digital mode

‘Background appearance’ area

Project	Selection	Alignment	Explanation
Appearance			
Colour	#00000ff		Colour specification filling colour (numerical or interactive)
Frame colour	#00000ff		Colour specification frame (numerical or interactive)
Frame size	1		Frame thickness (in pixels)
Shadow			Shadow ON/OFF
Shadow colour ¹	#0000080		Colour specification shadow (numerical or interactive)
Shadow x ¹	0		Shadow direction horizontal
Shadow y ¹	0		Shadow direction vertical
Shadow blur ¹	5		Shadow gradient (intensity)
Shadow width ¹	0		Shadow size
Internal frame ¹	<input type="checkbox"/>		Inner frame ON/OFF

¹ Additional parameters are **shown** when ‘Shadow’ option is enabled.

i *Colour selection*
 Numerical input using 8-digit hexadecimal value with leading number sign (hashtag). Colour values are formed as follows: **# RR GG BB TT**
R = red value; G = green value; B = blue value; T = transparency

5.5.2.7 ‘Value display’ area

Project	Selection	Alignment	Explanation
Value display			
Show state			Display state ON/OFF
State			Source, whose state is to be displayed
Colour if condition is true	#98cfdc		Colour specification TRUE

Colour if condition is false	#808284		Colour specification FALSE
Value		Text to be displayed	
Show text	<input checked="" type="checkbox"/>		Display text
Text if condition is true	ON	Text for TRUE	
Text if condition is false	OFF	Text for FALSE	

Additional parameters are **shown** when the option is activated

i **Colour selection**
 Numerical input using 8-digit hexadecimal value with leading number sign (hashtag). Colour values are formed as follows: **# RR GG BB TT**
R = red value; G = green value; B = blue value; T = transparency

5.5.2.8 'Font' area





Project	Selection	Alignment
Font		
Use global settings	<input checked="" type="checkbox"/>	



Additional parameters are **hidden** when the option 'Use global text settings' is activated.

Project	Selection	Alignment
Font		
Use global settings	<input type="checkbox"/>	
Font colour	#dedede	
regular	normal	100

5.6 Widget alignment

This section provides help for easy arrangement and alignment of the widgets on the display of the device.

Project	Selection	Alignment	Explanation
horizontal			Horizontal options
  			left-aligned, centred, right-aligned The fourth button formats selected widgets to the largest common width.

Project	Selection	Alignment	Explanation
vertical			Vertical options align to top, centre, bottom The fourth button formats selected widgets to the largest common height.
			
Distribute spaces			Distance distribution options The space between several selected widgets can automatically be distributed evenly in horizontal and vertical direction.
			

5.7 Guides and grid

5.7.1 Guides

Guides	Grid		Explanation	
Show guides	<input type="checkbox"/>		Guides ON/OFF	
Align to guides	<input type="checkbox"/>		Align widgets to guides ON/OFF	
<input type="checkbox"/>	vertical	400	✘	Display a configured vertical guide
<input type="checkbox"/>	horizontal	200	✘	Display a configured horizontal guide
+ Add guides			Add a guide	

5.7.2 Grid

Guides	Grid		Explanation
Show grid	<input type="checkbox"/>		Grid ON/OFF
Align to grid	<input type="checkbox"/>		Align widgets to grid ON/OFF
Size	10		Setting grid size

5.8 Used widgets

Widgets	
Widget_1	X
Widget_2	X
Widget_3	X
Widget...	X
Widget...	X

The list shows all widgets of the displayed dashboard. By clicking on an entry, the corresponding element is highlighted in yellow and can be edited. It can be deleted by clicking on the **X** in the respective widget.



Use the scroll bar (right) to navigate to hidden widgets.

6 Virtual devices

The concept of virtual devices involves combining existing measurements with other measurements in such a way that additional values, operating or alarm states can be displayed. Combine up to 26 measurements with numerical and logical operators to create a new 'virtual' measuring point. Each of these measuring points uses one channel. A virtual device consists of a maximum of 16 channels. Virtual devices are treated like real devices and are fully integrated into the Bender system: All calculated values

- can be stored in a data logger,
- are available via Modbus,
- can be displayed in a visualisation.

6.1 Application possibilities

Warnings

Alarms and warnings can be configured for Modbus devices. Through virtual devices, user-defined warning limits can be set for devices that do not offer this option (e.g. PEMs). Each generated warning appears in the warning history and can be used to send an e-mail notification.

Device failure monitoring

In large buildings with many devices installed in a production hall, department or floor, virtual devices simplify simultaneous monitoring for device failure. It allows narrowing down the location of the failure and enables fast intervention.

Converting to BMS bus (mirroring)

Operating states of the virtual devices can be transmitted via BMS bus even if the real devices have no BMS interface. For this purpose, the virtual devices are 'mirrored' to the BMS bus. The states of the measuring points (channels 1...12) are transmitted during the channel query of the BMS master.



*Only **operating states** are transmitted via the BMS bus (No alarm, Prewarning, Alarm). Specific measured values cannot be transmitted.*

6.2 Managing virtual devices

Path: Tools > Device management > Virtual devices

6.2.1 Virtual devices: Overview list/Main page

Address

Device addresses: 1...255

Alarm

Current operating state of the virtual device (prewarnings are displayed as alarms)



No Alarm



Alarm

Device name



Virtual devices are always named 'VD700...':

Mirrored

When enabled, the operating states of channels 1...12 of the virtual device are transmitted via BMS bus.

6.2.2 Editing a virtual device



Device address, device name and BMS mirroring can be edited.

6.2.3 Editing channels



In the channel overview, the 16 possible channels are displayed with the following information:

- Current operating state (no alarm Prewarning Alarm)
- Individual text for prewarning or alarm
- General and individual channel description
- Current measured value
- Defined formula

In the overview, channels can be created or edited via . Channels can be deleted via .



Refer to the 'Legend and examples' tab for assistance.

6.2.4 Deleting a device



A virtual device can be deleted via the bin.

6.2.5 Adding a virtual device

Use the button in the footer to add virtual devices.



The number of virtual devices that can be created depends on the COMTRAXX® device used or its active function modules.

Device address

Select a free bus address from the drop-down menu.



Virtual devices are treated like real devices. Therefore, addresses must not be assigned twice!

Device name

Assign a name to the virtual device.



Virtual devices are always named 'VD700...'. In addition, an individual name can be assigned.

Mirroring to BMS

If operating states are to be transmitted via BMS, this can be set here.



Virtual devices are treated like real devices. Therefore, addresses must not be assigned twice!

7 PROFINET

PROFINET is supported from COMTRAXX® version V4.6.0 and higher.

All measured values and alarm states in the system are made available via PROFINET. These can then be recorded and processed in a PLC or visualisation system. The integration into the respective PLC or visualisation system is done via the provided GSDML file.

In the COMTRAXX® device, only a device assignment is required to allocate the required data to the available PROFINET slots. The COMTRAXX® device is integrated into the PROFINET system as an IO device.

7.1 Configuration of the PROFINET interface

The PROFINET interface is configured in the menu of the COMTRAXX® device at **Menu > Settings > Interface > PROFINET**.

- Configure status of PROFINET on the COMTRAXX® device (factory setting: PROFINET off)
- Configure PROFINET device names (this can also be done via the PLC or similar system)
- Provision of GSDML file

The GSDML file is also available in the download area of our homepage at <https://www.bender.de/en/service-support/download-area/>

7.2 Device assignment for PROFINET

To make the required measured values or alarm states available via PROFINET, a device assignment must be generated for the PROFINET image. The device assignment defines on which PROFINET slot the respective measuring channel appears. The device assignment can either be done automatically or configured individually. A total of 255 slots are available, which can access all measuring channels in the system. Configuration is done at

 **Tools > Device management > Device assignment > PROFINET**.

i *If no device assignment is defined for a slot, the COMTRAXX® device will generate a diagnostic alarm when querying this slot. In addition, the data status (IO provider data) of the input data will be set to invalid!*

7.3 Data modules

The following data modules can be applied to the available 255 slots in the respective PLC or similar system. The various data modules define which data is to be read via a slot. For each data module, it is also possible to set in the respective PLC or similar system whether a process alarm is to be generated. The process alarm is triggered when the respective assigned measuring channel reports an active alarm. By default, this setting is disabled in the PLCs or similar systems.

Data module	Format	Comment/Unit
Measured value	Float32	Measured value of the measuring channel as floating point number (IEEE754) with 32 bits
Measuring channel structure (Complete measuring channel as a structure with 26 bytes)	UINT32	Time stamp in s as 32-bit unsigned integer (UTC)
	UINT16	Decimal places of the time stamp in ms as 16-bit unsigned integer
	INT16	Time stamp UTC Offset in minutes as 16-bit integer
	UINT32	Alarm time stamp in s as 32-bit unsigned integer (UTC)
	UINT16	Decimal places of the alarm time stamp in ms as 16-bit unsigned integer
	INT16	Alarm time stamp UTC Offset in minutes as 16-bit-integer
	Float 32	Measured value of the measuring channel as floating point number (IEEE754) with 32 bits
	UINT16	Description as 16-bit unsigned integer (see Channel descriptions for the process image)
Measuring channel structure (Complete measuring channel as a structure with 26 bytes)	UINT8	Alarm state as 8-bit unsigned integer 0 = No alarm 1 = Prewarning 2 = Error 3 = Reserved 4 = Warning 5 = Alarm
	UINT8	Unit as 8-bit unsigned integer (see R&U = Range and unit)
	UINT8	Value range as 8-bit unsigned integer 0 = Actual value 1 = Actual value is lower < 2 = Actual value is higher > 3 = Invalid value
	UINT8	Test state as 8-bit unsigned integer 0 = None 1 = Intern 2 = Extern
Alarm state	UINT8	Alarm state as 8-bit unsigned integer 0 = No alarm 1 = Prewarning 2 = Error 3 = Reserved 4 = Warning 5 = Alarm

7.4 Example of a data query

Example: Query measuring channel of an iso685-D

The iso685-D is connected to the COMTRAXX® device via BCOM. Measuring channel 3 (leakage capacitance C_e) is to be made available on slot 13 in order to be able to read it out via PROFINET.

In order for the required measuring channel to be read via PROFINET, it only has to be included in the device assignment. To do this, open the PROFINET device assignment of the COMTRAXX® device

 **Tools > Device management > Device assignment > PROFINET**

and click on the 'Add entry' button. Select slot and channel in the pop-up dialogue and confirm with 'Ok'.

The measuring channel now appears in the table and can be accepted with the 'Save changes' button. The configuration of the COMTRAXX® device is now complete and the measuring channel can be read on slot 13.

8 Modbus TCP server



Help tools that provide comprehensive information about Modbus can be found in the web user interface under

 **Tools > Service > Modbus**

- Generate control commands for BMS
- Display information on all available Modbus registers
- Generate Modbus documentation of all available Modbus registers of the connected devices

The Modbus TCP server supports the following function codes:

- Function code **0x03** (Read Holding Registers)
- Function code **0x04** (Read Input Registers)
- Function code **0x10** (Preset Multiple Registers)

The Modbus TCP server generates a function-related response to requests and sends it back to the Modbus TCP client.

8.1 Modbus requests

The required data of the system image are read from the COMTRAXX® device using the function codes **0x03** and **0x04**. For this purpose, the start address and the number of the registers to be read have to be entered. In addition, registers can also be written using function code **0x10**.

8.1.1 Example for function code 0x03

Configuration

- COMTRAXX® device in subsystem 1 with BCOM and BMS address 1
- BMS device on BMS interface with address 2

Task

- Read register 0x05 10 of the BMS device

Byte	Name	Bender modbus image V1	Bender modbus image V2
Byte 0, 1	Transaction identifier	0x00 00	0x00 00
Byte 2, 3	Protocol identifier	0x00 00	0x00 00
Byte 4, 5	Length field	0x00 06	0x00 06
Byte 6	Unit-ID	0x02 Device address assignment (0x02 corresponds to the device address 2 of the subsystem)	0x05 (address assignment via device assignment (0x05 = unit ID assigned by way of example for the device in the Modbus device assignment)
Byte 7	Modbus function code	0x03	0x03

Byte	Name	Bender modbus image V1	Bender modbus image V2
Byte 8, 9	Register start address	0x05 10	0x05 10
Byte 10, 11	Number of words	0x00 01	0x00 01

8.1.2 Example for function code 0x04

Configuration

- COMTRAXX® device in subsystem 1 with BCOM and BMS address 1
- BMS device on BMS interface with address 2

Task

- Read measured value from channel 1 of the BMS device

Byte	Name	Bender Modbus image V1	Bender Modbus image V2
Byte 0, 1	Transaction identifier	0x00 00	0x00 00
Byte 2, 3	Protocol identifier	0x00 00	0x00 00
Byte 4, 5	Length field	0x00 06	0x00 06
Byte 6	Unit-ID	0x01 Address assignment of the subsystem (0x01 corresponds to subsystem address 1)	0x0A Address assignment of the interface 0x0A = interface internal BMS
Byte 7	Modbus function code	0x04	0x04
Byte 8, 9	Register start address	0x02 10 Start register (0x02 = device address 2; 0x10 = start register for channel 1)	0x01 62 Start register (measured value channel 1)
Byte 10, 11	Number of words	0x00 02	0x00 02

8.1.3 Example for function code 0x10

Configuration

- COMTRAXX® device in subsystem 1 with BCOM and BMS address 1
- BMS device on BMS interface with address 2

Task

- Write value = 100 to register 0x05 10 of the BMS device

Byte	Name	Bender Modbus image V1	Bender Modbus image V2
Byte 0, 1	Transaction identifier	0x00 00	0x00 00
Byte 2, 3	Protocol identifier	0x00 00	0x00 00
Byte 4, 5	Length field	0x00 06	0x00 06
Byte 6	Unit-ID	0x01 Address assignment of the subsystem (0x01 corresponds to subsystem address 1)	0x0A Address assignment of the interface (0x0A = interface internal BMS)
Byte 7	Modbus function code	0x10	0x10
Byte 8, 9	Register start address	0x05 10	0x05 10
Byte 10, 11	Number of registers	0x00 01	0x00 01
Byte 12	Number of registers x2	0x02	0x02
Byte 13 - xx	Values	0x64	0x64

8.2 Modbus responses

The responses consist of 2 bytes per register. The byte sequence is MSB (Most Significant Bit, Big Endian) first.

8.2.1 Responses for function code 0x03 and 0x04

Byte	Name	Example
Byte 1...6	Identical with request	
Byte 7	Modbus function code	0x03 or 0x04
Byte 8	Byte count	0x04
Byte 9, 10	Value register 0	0x12 34 (fictitious value)
Byte 11, 12	Value register 1	0x23 45 (fictitious value)

8.2.2 Responses for function code 0x10

Byte	Name	Beispiel
Byte 1...6	Identical with request	
Byte 7	Modbus function code	0x10
Byte 8, 9	Register start address	0x12 34 (fictitious value)
Byte 10, 11	Number of registers	0x00 12 (fictitious value)

8.2.3 Exception code

If a request cannot be answered for whatever reason, the Modbus TCP server sends an exception code with which possible faults can be narrowed down.

Overview of exception codes

Exception code	Description
0x01	Impermissible function
0x02	Impermissible data access
0x03	Impermissible data value
0x04	Slave device error
0x05	Acknowledgement of receipt (response delayed)
0x06	Request not accepted (repeat request if necessary)
0x08	Memory: Parity Error
0x0A	Gateway path not available
0x0B	Gateway error

Structure of the exception code

Byte	Name	Example
Byte 1...6	Identical with request	
Byte 7	Modbus function code	0x84
Byte 8	Exception code	

8.3 Modbus system image

The COMTRAXX® device stores a system image in the internal memory. This shows the present values and states of all devices that are connected via the device. The system image depends on which Bender Modbus image (V1 or V2) is active on the COMTRAXX® device.

Starting from COMTRAXX® version V4.00, address assignment by interfaces is introduced. Each interface now has its own address range. This means that there can be several devices with the same device address in the system if they are connected via different interfaces.

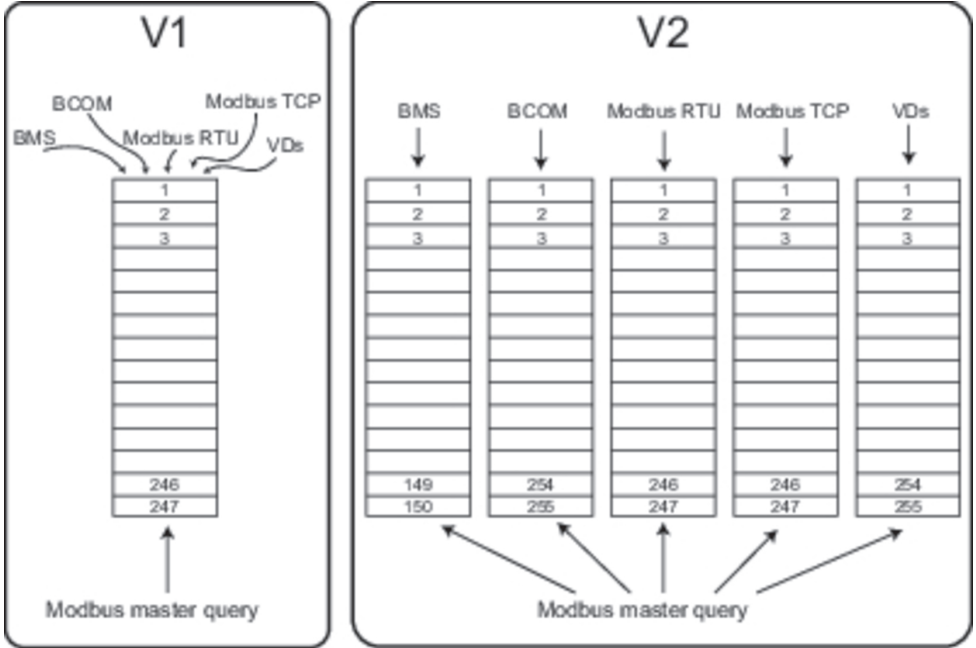

Image 8-1: Differences between Bender Modbus images V1 and V2

In the **Bender Modbus image V1**, all interfaces share a common address range; in the **Bender Modbus image V2**, each interface has its own address range. The Bender Modbus image V2 guarantees a unique and collision-free access to the device data.

i After updating an existing device to V4.0, the Bender Modbus image is still set to V1. On newly delivered devices, V2 is active by default. The Bender Modbus image is configured in the device menu of the COMTRAXX® device at **Settings > Interface > Modbus**

8.4 Bender Modbus image V1 (one address range for all interfaces)

If the Bender Modbus image is set to V1, the Modbus data are provided as follows:

8.4.1 Querying data with Modbus function code 0x03

The parameters and measured values of all devices in the subsystem can be read using the Modbus function code **0x03** (Read Holding Registers). This is only possible on the subsystem level, not in the entire system. The unit ID refers to the respective device address.

8.4.2 Querying data with Modbus function code 0x04

The system image in the memory of the COMTRAXX® device can be read using the Modbus function code **0x04** (Read Input Registers).

The following information is available for all devices in the system:

- Device name
- Channel states
- Alarm and operating messages

The unit ID refers to the subsystem address.

The volume of the queried data depends on the number of bytes selected in the Modbus client used. Up to 125 words (0x7D) can be read with a single query. An individual word can also be read, for example, to detect the set bit for a saved common alarm.

8.4.3 Writing data with Modbus function code 0x10

The parameters of all devices located in the same subsystem can be written using the Modbus function code **0x10** (Preset Multiple Registers). This is only possible at subsystem level, but not in the whole system. The unit ID refers to the respective device address.



To make it easier to configure device parameters via Modbus TCP, the register addresses for each parameter can be displayed in the device menus. Activate this function at the menu item

Tools > Service > Parameter addresses

8.4.4 Distribution of the memory areas

Memory utilisation	Start address	End of memory area	Size of memory area
Reference values for test purposes	0x0000	0x00FF	0x0100
System image	0x0100	0x95FF	0x9500
Not used	0x96FF	0xFFFF	0x6900



For some Modbus clients an offset of 1 must be added to the register addresses. Example: process image start address = 0x0101.

The assignment of the memory addresses and the associated memory content for one subsystem is described below. Please refer also to the 'BCOM' manual, which provides information about the entire addressable system.

8.4.5 Memory scheme of the system image

Structure of the system image

As illustrated in the table, the Modbus start address for the respective system image is derived from the device address.

256 (0x100) words or 512 bytes are reserved for each device. They contain all information requested and transmitted on the interface.

Modbus start addresses for each device for which a request can be sent (V1)

		Modbus address ranges of the process images in the memory		
Device address	Word			
	HiByte	LoByte		
		00	...	FF
1	0x01	Device 1		
2	0x02	Device 2		
3	0x03	Device 3		
...		
32	0x20	Device 32		
...		
255	0xFF	Device 255		

8.4.6 Memory scheme of an individual device

Devices can feature various types of analogue and/or digital channels. Please note the device-specific differences:

- BMS devices usually feature 12 channels
- MK800/TM800 supports up to 64 digital channels in the master mode

After determining the start address, the following unit parameters can be queried:

- Device type
- Timestamp
- Common alarm
- Device error
- Channel information

8.4.7 Example: Determine start address

Channel 2 des Geräts mit der Adresse 3 soll abgefragt werden. Wie wird die Start-Adresse zur Abfrage des Channels gebildet? Für dieses Beispiel sind die relevanten Zellen *fett* Channel 2 of the device with address 3 is to be queried. How is the start address determined to send the query for the channel? In our example, the relevant cells in the table are marked in **bold**.

1. For device address 3, the first address part 0x03 (HiByte) is taken from Table.Abbreviation 7: Modbus start addresses for each device for which a request can be sent (V1).
2. For channel 2, the second address part 0x14 (LoByte) is taken from Table.Abbreviation 8: Modbus address assignment of the channels in a device (V1).
3. For the number of words to be queried, the number 4 is taken from the same table: (0x14 to 0x17 = 0x04).
4. The start address 0x0314 is formed by HiByte and LoByte

Modbus address assignment of the channels in a device (V1)

Memory image of a device																
LoByte	0	1	2	3	4	5	6	7	8	9	A	B	C	D	E	F
0x00	Device type										Timestamp			C	D	R
0x10	Channel 1				Channel 2				Channel 3				Channel 4			
0x20	Channel 5				Channel 6				Channel 7				Channel 8			
0x30	Channel 9				Channel 10				Channel 11				Channel 12			
0x40	Channel 13				Channel 14				Channel 15				Channel 16			
0x50	Channel 17				Channel 18				Channel 19				Channel 20			
0x60	Channel 21				Channel 22				Channel 23				Channel 24			
0x70	Channel 25				Channel 26				Channel 27				Channel 28			
0x80	Channel 29				Channel 30				Channel 31				Channel 32			
0x90	33 34	35 36	37 38	39 40	41 42	43 44	45 46	47 48	49 50	51 52	53 54	55 56	57 58	59 60	61 62	63 64
0xA0	Reserved															
0xB0	Reserved															
0xC0	Reserved															
0xD0	Reserved															
0xE0	Reserved															
0xF0	Reserved															

Hex representation:

horizontal = units

vertical = sixteens

Abbreviations for memory contents:

C = Common alarm

D = Device lost (device failure)

R = Reserved

8.4.8 Data formats

Device type

The device type is set using a bus scan.

Data format device type

Word 0x00	0x01	0x02	0x03	0x04	0x05	0x06	0x07	0x08	0x09
ASCII text, 10 Words/20 Bytes									

Timestamp

The timestamp is set according to a datagram received from a transmitting device.

Data format time stamp

Word 0x0A		0x0B		0x0C		0x0D	
HiByte	LoByte	HiByte	LoByte	HiByte	LoByte	HiByte	LoByte
Year YY		Month MM	Day DD	Hour hh	Minute mm	Second ss	Reserved

C = Common alarm and D = Device lost (device failure)

Data format common alarm and device failure

Word 0x0E	
HiByte	LoByte
C	D
Common alarm, 1byte: LSB = 0 or 1	Device error, 1 byte: LSB = 0 or 1

The common alarm bit is set as soon as an alarm status from the respective device is detected.

The device error bit is set when the communication with the respective device is no longer possible.

Channels 1...32 with analogue and/or digital values

Every analogue device channel can contain alarm messages, operating messages, measured values, test messages and descriptive text.

Both analogue and digital information can be transmitted.

- A&T = Alarm-Typ and Test-Art (internal/external)
- R&U = Range and unit

For details on the channel description refer to Channel descriptions for the process image (V1 and V2).

Channels 1...32: Data format analogue/digital values

Word 0x00		0x01		0x02		0x03	
HiByte	LoByte	HiByte	LoByte	HiByte	LoByte	HiByte	LoByte
Floating point value (Float)				A&T	R&U	Channel description	

Float = Floating point value of the channels

Channels 1...32: Data format floating point values

Word	0x00																0x10																			
Byte	HiByte								LoByte								HiByte								LoByte											
Bit	31	30						24	23							16	15									8	7									0
	S	E	E	E	E	E	E	E	E	M	M	M	M	M	M	M	M	M	M	M	M	M	M	M	M	M	M	M	M	M	M	M	M	M	M	

Representation of the bit order for processing analogue measured values according to IEEE 754

S = Sign

E = Exponent

M = Mantissa

A&T = Alarm type and test type (internal/external)

The alarm type is coded by the bits 0...2.

The bits 3 and 4 are reserved and always have the value 0.

Bit 5 usually has the value 0 and represents the digital value of the status (this column is only relevant for the SMI472).

Bit 6 or 7 are usually set when an internal or external test has been completed. Other values are reserved.

The complete byte is calculated from the sum of the alarm type and the test type.

Channels 1...32: Data format A&T

Bit	7	6	5	4	3	2	1	0	Bedeutung
	a)	b)	c)	d)	d)	e)	f)		
Alarm type	-	-	-	-	-	0	0	0	No alarm
	-	-	-	-	-	0	0	1	Prewarning
	0	0	-	-	-	0	1	0	Device error
	-	-	-	-	-	0	1	1	Reserved
	-	-	-	-	-	1	0	0	Alarm (yellow LED), e.g. insulation fault
	-	-	-	-	-	1	0	1	Alarm (red LED)
	-	-	-	-	-	1	1	0	Reserved
	-	-	-	-	-	1	1	1	Reserved
Test	0	0	-	-	-	-	-	-	No test
	0	1	-	-	-	-	-	-	Internal test
	1	0	-	-	-	-	-	-	External test

a) = External test

b) = Internal test

c) = Status

d) = Reserved

e) = Alarm

f) = Error

R&U = Range and Unit

The unit is coded in the bits 0...4.

Bit 5 is reserved.

The bits 6 and 7 describe the range of validity of a value.

The complete byte is calculated from the sum of the unit and the range of validity.

Channels 1...32: Data format R&U

Bit	7	5	5	4	3	2	1	0	Description
Unit	-	-	-	0	0	0	0	0	Invalid(init)
	-	-	-	0	0	0	0	1	No unit
	-	-	-	0	0	0	1	0	Ω
	-	-	-	0	0	0	1	1	A
	-	-	-	0	0	1	0	0	V
	-	-	-	0	0	1	0	1	%
	-	-	-	0	0	1	1	0	Hz
	-	-	-	0	0	1	1	1	Baud
	-	-	-	0	1	0	0	0	F
	-	-	-	0	1	0	0	1	H
	-	-	-	0	1	0	1	0	°C
	-	-	-	0	1	0	1	1	°F
	-	-	-	0	1	1	0	0	Second
	-	-	-	0	1	1	0	1	Minute
	-	-	-	0	1	1	1	0	Hour
-	-	-	0	1	1	1	1	Day	
-	-	-	1	0	0	0	0	Month	
	-	-	-	1	Reserved
	-	-	-	1	1	1	1	0	CODE
	-	-	-	1	1	1	1	1	Reserved
	-	-	1	
	-	-	1	1	1	1	1	1	
Range of validity	0	0	-	-	-	-	-	-	Actual value
	0	1	-	-	-	-	-	-	The actual value is lower
	1	0	-	-	-	-	-	-	The actual value is higher
	1	1	-	-	-	-	-	-	Invalid value



If the unit byte (0...4) refers to CODE, the recorded value or status will result in a text message.

The content of this text message is listed in the table Channel descriptions for the process image (V1 and V2). The floating point value contains an internal CODE but no valid measured value.

Channel description

A code with the associated descriptive text is available for each channel. For a complete list of the available codes or texts refer to Channel descriptions for the process image (V1 and V2).

Channels 33...64

The channels 33...64 only provide digital information. The information is coded as alarm or message type as well as test type (internal/external). The coding is similar to the A&T data format for channels 1...32 except for the additional bit 4, which is used for coding device errors, e.g. connection faults or internal device errors.

Channels 33...64: Data format A&T

Bit	7	5	5	4	3	2	1	0	Bedeutung
	a)	b)	c)	d)	e)	f)	g)		
Alarm-Typ	-	-	-	-	-	0	0	0	Kein Alarm
	-	-	-	-	-	0	0	1	Vorwarnung
	0	0	-	-	-	0	1	0	Gerätefehler
	-	-	-	-	-	0	1	1	Reserviert
	-	-	-	-	-	1	0	0	Alarm (gelbe LED) z. B. Isolationsfehler
	-	-	-	-	-	1	0	1	Alarm (rote LED)
	-	-	-	-	-	1	1	0	Reserviert
	-	-	-	-	-	1	1	1	Reserviert
Test	0	0	-	-	-	-	-	-	Kein Test
	0	1	-	-	-	-	-	-	Interner Test
	1	0	-	-	-	-	-	-	Externer Test

- a) = External test
- b) = Internal test
- c) = Status
- d) = Device error
- e) = Reserved
- f) = Alarm
- g) = Error

8.4.9 Modbus example for reading data (V1)

Example: Reading out from ATICS channel 1 (voltage line 1)

Reading out from ATICS channel 1 (voltage line 1) The COMTRAXX® device has address 1 in subsystem 1. ATICS channel 1 of internal address 3 is to be read out. The content is the voltage of line 1 as floating point value.

Modbus request for 'reading data (V1)'

00 01 00 00 00 06 01 04 03 10 00 02

- 00 01 Transaction ID (is generated automatically)
- 00 00 Protocol ID
- 00 06 Length
- 01 Unit ID (subsystem 1)
- 04 Modbus Function Code 0x 04 (read input registers)

03 10 Start register
 (register address at which the value appears in the memory image: 784 = 0x 03 10)
 00 02 Length of the data (words)

Modbus response for 'reading data (V1)'

00 01 00 00 00 05 01 04 04 01 00 43 63 00 04

00 01 Transaction ID (is generated automatically)
 00 00 Protocol ID
 00 05 Length
 01 Unit ID (device address of the COMTRAXX® device)
 04 Modbus Function Code 0x 04 (read input registers)
 04 Length of the data (bytes)
 01 00 43 63 Data floating point value (0x 43 63 01 00 (words swapped) = 227.0039)
 00 04 Alarm and test type (00 = no alarm), range and unit (04 = volts)

8.4.10 Reference data records of the process image

To make it easier to check the configuration and the Modbus TCP data access to devices, the COMTRAXX® device provides a reference data record at the **virtual** address 0

i *No real device can have address 0! Address 0 only serves to simulate data access.*

Special features of the Modbus communication are the byte offset and the word and byte order in the memory (Big Endian, MSB). At the end of this chapter, a few examples of correct configuration are given, which might be helpful.

8.4.11 Address assignment of the reference data record

As shown in the following table, the Modbus start address for access to the reference data record is derived from device address 0.

Start addresses for the reference data record query

Virtual device address	Word				
	HiByte	LoByte			
		00	0E	10	14
0	0x00	Device type	Common alarm	Channel 1	Channel 2

The start addresses provide the following reference values

- 0x0000: TEST (device type)
- 0x000E: 1 (common alarm, LSB of the HiByte is set)
- 0x0010: 230 V undervoltage (reference value on channel 1)
- 0x0014: 12.34 A overcurrent (reference value on channel 2)

8.4.12 Reference value on channel 1

The following reference value is stored in this channel: 230.0 V undervoltage

Stored reference data (channel 1)

Word 0x10		0x11		0x12		0x13	
HiByte	LoByte	HiByte	LoByte	HiByte	LoByte	HiByte	LoByte
0x43	0x66	0x00	0x00	0x00	0x04	0x00	0x4D
Floating point value (Float)				A&T	R&U	Description	
230.0				No/No	Volt	Undervoltage	

8.4.13 Reference value on channel 2

The following reference value is stored in this channel: 12.34 A

Stored reference data (channel 2)

Word 0x14		0x15		0x16		0x17	
HiByte	LoByte	HiByte	LoByte	HiByte	LoByte	HiByte	LoByte
0x41	0x45	0x70	0xA4	0x00	0x03	0x00	0x4A
Floating point value(Float)				A&T	R&U	Description	
12.34				No/No	Ampere	Overcurrent	

8.4.14 Explanation of how to access floating point values

The test value 12.34 can be read out via Modbus TCP using the Modbus function code **0x04** at the address 0x0014. The test value has a size of 2 words.

Proceed as follows:

1. **Determine the correct byte offset**

Interpreting both words as unsigned integer values should result in the following values: Word 1 with address 0x14: unsigned integer value => 16709 (0x4145) Word 2 with address 0x15: unsigned integer value => 28836 (0x70A4)

2. **Determine the correct byte or word swap**

There are four different combinations of swapping. The only correct value is 12.34. All swapping combinations are represented in the following table:

Hex value sequence	Word 1		Word 2		Floating point value
	Byte 1	Byte 2	Byte 3	Byte 4	
CORRECT	A 41	B 45	C 70	D A4	12.34
Word swapping	C 70	D A4	A 41	B 45	4.066E+29

Hex value sequence	Word 1		Word 2		Floating point value
	Byte 1	Byte 2	Byte 3	Byte 4	
Byte swapping	B 45	A 41	D A4	C 70	3098.27
Word and byte swapping	D A4	C 70	B 45	A 41	-5.21E-17

8.5 Bender Modbus image V2

(one address range for each interface)

If the Bender Modbus image is set to V2, the Modbus data are provided as follows.

8.5.1 Function codes (V2)

Function code 0x03 (Read Holding Registers):

Querying data from the Modbus device assignment table

- **Reading** the parameters and measured values of all devices in the system
- Modbus device assignment must be performed before use, because the unit ID in the Modbus request refers to the respective unit ID assigned in the Modbus device assignment.
- The device assignment determines which devices are accessible via **0x03**.
- 255 addresses are available, which can be configured freely.
- The device assignment takes place in the COMTRAXX® device at

 **Device management > Device assignment > Modbus.**

Function code 0x10 (Write Multiple Registers):

Writing data

Writing the parameters of all devices in the subsystem

For the Modbus request, the unit ID refers to the interface via which the corresponding device is integrated.

 *To set parameters for devices via Modbus TCP, a device assignment must first be made in order to obtain unique unit IDs:*

Um eine Parametrierung von Geräten über Modbus TCP durchzuführen, muss zunächst eine Gerätezuordnung vorgenommen werden, um eindeutige Unit-IDs zu erhalten:

 **Tools > Device management > Device assignment > Modbus.**

Note that there may be a time delay of up to 3 minutes in BMS bus operations before changes become visible.

 *To make it easier to configure device parameters via Modbus TCP, the register addresses for each parameter can be displayed in the device menus. Activate this function at the menu item*

 **Tools > Service > Parameter addresses**

Function code 0x04 (Read Input Registers): Querying data from the system image

- **Reading** the system image from the COMTRAXX® device memory.
- Querying device names, channel states, alarm and operating messages from all devices connected via the COMTRAXX® device.
- Here, the unit ID refers to the interface via which the corresponding device is connected.
- The volume of the queried data depends on the number of bytes selected in the Modbus client used.
- Up to 125 words (0x7D) can be read with a single query.

8.5.2 Distribution of the memory areas (V2)

Unit-ID	Interface	Maximum No. of devices	Measuring points per device	Register per device	Device/Register per unit ID	Device/Register last unit ID	Start address	End address
1	COMTRAXX® device information	1	550	8880	1/8880	-	0	8879
10	Internal BMS	150	12	272	150 / 40800	-	0	40799
20... 28	Modbus RTU	247	128	2128	30 / 63840	7 / 14896	0 (per unit ID)	14895 (Unit-ID 28)
40... 48	Modbus TCP	247	128	2128	30 / 63840	7 / 14896	0 (per unit ID)	14895 (Unit-ID 48)
60... 68	BCOM	255	128	2128	30 / 63840	15 / 31920	0 (per unit ID)	31919 (Unit-ID 68)
90... 91	Virtual devices	255	16	336	195 / 65520	60 / 20160	0 (per unit ID)	20159 (Unit-ID 91)
95	I ² C	127	16	336	127 / 42672	-	0	42671
101... 199 1)	2)	150 per unit ID	12	272	150 / 40800	-	0 (per unit ID)	40799 (Unit-ID 199)

1) Only for devices with the corresponding interface; otherwise: reserved

2) External BMS: Here, the unit ID represents an external BMS address .
BMSe Addr. 10 = unit ID 110



For some Modbus clients an offset of 1 must be added to the register addresses.

Example: process image start address = 0x0101.

8.5.3 Memory scheme of the system image (V2)

Structure of the system image

As illustrated in the table, the Modbus start address for the respective system image is derived from the device address. It contains all information requested and transmitted on the interface

Example: Internal BMS

Unit ID	Device address	Modbus address ranges of the data in the memory	
		Start register	End register
10	1	0 (272 x 0)	271 (272 x 1 - 1)
10	2	272 (272 x 1)	543 (272 x 2 - 1)
10	3	544 (272 x 2)	815 (272 x 3 - 1)
...			
10	30	7888 (272 x 29)	8159 (272 x 30 - 1)
10	31	8160 (272 x 30)	8431 (272 x 31 - 1)
...			
10	150	40528 (272 x 149)	40799 (272 x 150 - 1)

Example: Modbus TCP

Unit ID	Device address	Modbus address ranges of the data in the memory	
		Start register	End register
40	1	0 (2128 x 0)	2127 (2128 x 1 - 1)
40	2	2128 (2128 x 1)	4255 (2128 x 2 - 1)
40	3	4256 (2128 x 2)	6383 (2128 x 3 - 1)
...			
40	30	61712 (2128 x 29)	63.839 (2128 x 30 - 1)
40	31	0 (2128 x 0)	2127 (2128 x 1 - 1)
...			
40	247	12768 (2128 x 6)	14.895 (2128 x 7 - 1)

8.5.4 Memory scheme of a device (V2)

Example: Memory scheme V2: Device internal BMS

Each device is managed via an individual device image in the memory. Its first block provides the device information. Afterwards, the individual measured value/channel information is displayed. The size of the block depends on how many measured values a device provides.

Device (V2)

Default values in case no values are available for the requested register:

- UINT16: 65.535 (all bits are set)
- UINT32: 4.294.967.295 (all bits are set)
- String: empty string (value 0)
- Float: NaN (all bits are set)

Offset	Hex	Type	Length in Words	Extended description
0	0	String	10	Device name
10	A	String	10	Serial number of the device
20	14	UINT32	2	Last contact (time stamp in seconds since 01.01.1970)
22	16	UINT16	1	Device status 2 = Inactive (Device is not active. However, devices connected to this device are monitored for failure) 3 = Active (Device is active) 4 = Lost (Device is not active but is monitored for failure)
23	17	UINT16	1	Sum of all messages (alarm, warning, prewarning, device error)

Offset	Hex	Type	Length in Words	Extended description
24	18	UINT16	1	Number of alarms
25	19	UINT16	1	Number of warnings
26	1A	UINT16	1	Number of prewarnings
27	1B	UINT16	1	Number of device errors
28	1C	UINT16	52	Individual device range, the content depends on the respective device
			Sum = 80	

Example: Memory scheme V2: Device internal BMS

Description	Words
Device information	80
Measured values	192 (12 channels x 16 words per channel))
Total	272

Measured value (V2)

Offset	Hex	Type	Length in words	Extended description
0	0	UINT32	2	Time stamp in seconds since 01.01.1970
2	2	Float	2	Measured value (NAN if not valid)
4	4	Float	2	Response value (not available for every device; if not available, NAN)
6	6	Float	2	Response value for prewarning (not available for every device; if not available, NAN)
8	8	UINT16	1	Alarm type 0 = None 1 = Prewarning 2 = Fault 4 = Warning 5 = Alarm

Offset	Hex	Type	Length in words	Extended description
9	9	UINT16	1	Unit 1 = None 2 = Ohm 3 = Ampere 4 = Volt 5 = Percent 6 = Hertz 7 = Baud 8 = Farad 9 = Henry 10 = °Celsius 11 = °Fahrenheit 12 = Second 13 = Minute 14 = Hour 15 = Day 16 = Month 17 = Watt 18 = var 19 = VA 20 = Wh 21 = varh 22 = VAh 23 = Degree 24 = HertzPerSecond 25 = NonewithConvert 26 = Bar 30 = Textcode
10	A	UINT16	1	Validity 0 = Actual value 1 = Actual value is lower < 2 = Actual value is higher > 3 = Invalid value
11	B	UINT16	1	Test 0 = None 1 = Internal 2 = External
12	C	UINT16	1	Description
13	D	UINT16	1	Special text code (if the unit is set to text code (30), NAN is output on the measured value)

Offset	Hex	Type	Length in words	Extended description
14	E	UINT16	1	Compressed channel state Bit coded 1 = Message present 2 = Prewarning 4 = Fault/Alarm/Warning 8 = Internal test 16 = External test
15	F		1	Reserved
			Sum = 16	

8.5.5 Modbus example for reading data (V2)

Example: Reading out from ATICS channel 1 (voltage line 1)

The COMTRAXX® device has address 1 in subsystem 1.

Channel 1 of an ATICS is to be read out at the internal BMS with address 3. The content is the voltage of line 1 as floating point value.

Modbus request for 'reading data (V2)'

00 01 00 00 00 06 0A 04 02 72 00 02

00 01	Transaction ID (is generated automatically)
00 00	Protocol ID
00 06	Length
0A	Unit-ID (internal BMS)
04	Modbus Function Code 0x 04 (read input registers)
02 72	Start register (272 [words per device] * 2 [address 3] + 82 [Start register measured value channel 1])
00 02	Length of the data (words)

Modbus response for 'reading data (V2)'

00 01 00 00 00 05 0A 04 04 01 00 43 63 00 04

00 01	Transaction ID (is generated automatically)
00 00	Protocol ID
00 05	Length
0A	Unit-ID (internal BMS)
04	Modbus Function Code 0x 04 (read input registers)
04	Length of the data (bytes)
01 00 43 63	Data floating point value (0x 43 63 01 00 (words swapped) = 227.0039)
00 04	Alarm and test type (00 = no alarm), range and unit (04 = volts)

8.5.6 Reference data records of the system image (V2)

To check the configuration and the Modbus TCP data access, internal registers of the COMTRAXX® device can be retrieved with function code **0x04**.

Address assignment of the reference data record

Information on the COMTRAXX® device can be retrieved in the following registers. This can be used to check the configuration and the Modbus TCP data access to the device.

Modbus address ranges of the data in the memory						
Content	Unit-ID	Device address	Start register	End register	Type	Length
Device name	1	1	0x00 00	0x00 09	String	10 words
Serial number	1	1	0x00 0A	0x00 13	String	10 words

8.6 Channel descriptions for the process image (V1 and V2)

Channel descriptions for the process image

Value	Measured value description Alarm message Operating message	Description
1 (0x01)	Insulation fault	
2 (0x02)	Overload	
3 (0x03)	Overtemperature	
4 (0x04)	Failure line 1	
5 (0x05)	Failure line 2	
6 (0x06)	Insul. OT light	Insulation fault operating theatre light
7 (0x07)		
8 (0x08)	Distribution board failure	
9 (0x09)	Failure oxygen	
10 (0x0A)	Failure vacuum	
11 (0x0B)	Anaesthetic gas	
12 (0x0C)	Compressed air 5 bar	
13 (0x0D)	Compressed air 10 bar	
14 (0x0E)	Failure nitrogen	
15 (0x0F)	Failure CO2	
16 (0x10)	Insulation UPS	Insulation fault UPS
17 (0x11)	Overload UPS	
18 (0x12)	Converter UPS	
19 (0x13)	UPS fault	

Value	Measured value description Alarm message Operating message	Description
20 (0x14)	UPS emergency peration	
21 (0x15)	UPS test run	
22 (0x16)	Failure air conditioning	
23 (0x17)	Batt.op. OP-L	Battery-operated operating theatre light
24 (0x18)	Batt.op. OP-S	Battery-operated Sat operating theatre light
25 (0x19)	Fail.norm.supply	Line normal power supply
26 (0x1A)	Fail.safet.supply	Line safety power supply
27 (0x1B)	Failure UPS	Line additional safety power supply
28 (0x1C)	Ins.safety supply	
29 (0x1D)	Fail.N conductor	
30 (0x1E)	Short dist. panel	Distribution panel short circuit
31 (0x1F)	Reserved	
32 (0x20)		
33 (0x21)		
34 (0x22)		
35 (0x23)	Standby function	(Measuring function switched off (standby))
36 (0x24)		
37 (0x25)		
38 (0x26)	Batt.op. UPS	Battery operation, special safety power supply
39 (0x27)	Phase sequ. left	
40 (0x28)	Failure line BPS	Battery-supported safety power supply
41 (0x29)	Reserved	
...		
66 (0x42)		
67 (0x43)	Function test until:	Date
68 (0x44)	Service until:	Date
69 (0x45)	Ins.fault locat.	Insulation fault location
70 (0x46)	peak	Fault EDS system

Value	Measured value description Alarm message Operating message	Description
71 (0x47)	Insulation fault	Insulation resistance in W
72 (0x48)	Current	Measured value in A
73 (0x49)	Undercurrent	
74 (0x4A)	Overcurrent	
75 (0x4B)	Residual current	Measured value in A
76 (0x4C)	Voltage	Measured value in V
77 (0x4D)	Undervoltage	
78 (0x4E)	Overvoltage	
79 (0x4F)	Frequency	Measured value in Hz
80 (0x50)	Reserved	
81 (0x51)	Unbalance	
82 (0x52)	Capacitance	Measured value in F
83 (0x53)	Temperature	Measured value in °C
84 (0x54)	Overload	Measured value in %
85 (0x55)	Digital input	State 0 or 1
86 (0x56)	Insulation fault	Impedance
87 (0x57)	Insulation fault	Alarm from an insulation fault locator
88 (0x58)	Load	Measured value in %
89 (0x59)	Total Hazard Current	THC
90 (0x5A)	Inductance	Measured value in H
...	Reserved	
97 (0x61)	Service code	Information about service intervals
...	Reserved	
101 (0x65)	Mains power connection	
102 (0x66)	Earth connection	
103 (0x67)	Short-circuit transformer	CT short circuit
104 (0x68)	No CT connected	
105 (0x69)	Short temp.sensor	Temperature sensor short circuit
106 (0x6A)	Temp.sensor open.	Connection temperature sensor

Value	Measured value description Alarm message Operating message	Description
107 (0x6B)	K1	Fault contactor K1
108 (0x6C)	K2	Fault contactor K2
109 (0x6D)	Reserved	
110 (0x6E)		
111 (0x6F)	No address:	Failure BMS device
112 (0x70)	Reserved	
113 (0x71)	Failure K1/Q1	Failure contactor K1/Q1
114 (0x72)	Failure K2/Q2	Failure contactor K2/Q2
115 (0x73)	Device error	Fault ISOMETER
116 (0x74)	Manual mode K1/2	Manual mode
117 (0x75)	Open circuit K1 on	Line to K1 interrupted on
118 (0x76)	Open circuit K1 off	Line to K1 interrupted off
119 (0x77)	Open circuit K2 on	Line to K2 interrupted on
120 (0x78)	Open circuit K2 off	Line to K2 interrupted off
121 (0x79)	K/Q1 on	Fault
122 (0x7A)	K/Q1 off	Fault
123 (0x7B)	K/Q2 on	Fault
124 (0x7C)	K/Q2 off	Fault
125 (0x7D)	FailureK3	
126 (0x7E)	Q1	Fault
127 (0x7F)	Q2	Fault
128 (0x80)	No master	
129 (0x81)	Device error	
130 (0x82)	Reserved	
131 (0x83)	Fault RS485	

Value	Measured value description Alarm message Operating message	Description
132 (0x84)	Reserved	
133 (0x85)		
134 (0x86)		
135 (0x87)		
136 (0x88)		
137 (0x89)	Short circuit Q1	
138 (0x8A)	Short circuit Q2	
139 (0x8B)	CV460	CV460 fault
140 (0x8C)	RK4xx	Fault RK4xx
141 (0x8D)	Address collision	BMS address has been assigned several times
142 (0x8E)	Invalid address	
143 (0x8F)	Several masters	
144 (0x90)	No menu access	
145 (0x91)	Own address	
...	Reserved	
201 (0xC9)	Line 1 normal op	
202 (0xCA)	Line 2 normal op	
203 (0xCB)	Switch. el. 1 on	
204 (0xCC)	Switch. el. 2 on	
205 (0xCD)	Reserved	
206 (0xCE)	Auto mode	
207 (0xCF)	Manual mode	
208 (0xD0)	Reserved	
209 (0xD1)		
210 (0xD2)	Line AV on	
211 (0xD3)	Line SV on	
212 (0xD4)	Line UPS on	
213 (0xD5)	Channel disabled	

Value	Measured value description Alarm message Operating message	Description
214 (0xD6)	Switch-back lock	Switch-back lock enabled
215 (0xD7)	Phase sequ. right	
216 (0xD8)	Switch. el. pos.0	
217 (0xD9)	Line BPS on	
218 (0xDA)	On	SMO48x: Alarm, relay

To convert parameter data, data type descriptions are required. Text representation is not necessary in this case.

Data type descriptions

Value	Description of parameters
1023 (0x3FF)	Parameter/measured value invalid. The menu item for this parameter is not displayed
1022 (0x3FE)	No measured value/no message
1021 (0x3FD)	Measured value/parameter inactive
1020 (0x3FC)	Measured value/parameter only temporarily inactive (e.g. during the transfer of a new parameter). Display in the menu '...'
1019 (0x3FB)	Parameter/measured value (value) unit not displayed
1018 (0x3FA)	Parameter (code selection menu) unit not displayed
1017 (0x3F9)	String max. 18 characters (e.g. device type, device variant, ...)
1016 (0x3F8)	Reserved
1015 (0x3F7)	Time
1014 (0x3F6)	Date day
1013 (0x3F5)	Date month
1012 (0x3F4)	Date year
1011 (0x3F3)	Register address (unit not displayed)
1010 (0x3F2)	Time
1009 (0x3F1)	Multiplication [*]
1008 (0x3F0)	Division [/]
1007 (0x3EF)	Baud rate

8.7 Modbus control commands

Commands can be sent to BMS devices by an external application (e.g. a visualisation software).

This functionality can be activated or deactivated via the web user interface.

Command structure

Write				Read
Word 0xFC00	0xFC01	0xFC02	0xFC03	0xFC04
External BMS bus address ¹⁾	Internal BMS bus address	BMS channel	Command	Status

¹⁾ Only for devices with the corresponding interface; otherwise: reserved.

8.7.1 Writing to registers

- Use function code **0x10** (Preset Multiple Registers) for writing.
- Start address: 0xFC00
- Number: 4 registers
- Always set all four registers (word 0xFC00...0xFC03) at the same time. This statement also applies if individual registers remain unchanged.
- If no other subsystem is available, enter value '1' in this register.
- If a BMS channel number is not required, enter value '0' (zero) in this register



*Control commands can also be generated in the menu **Service > Modbus > Modbus control commands**.*

8.7.2 Reading registers

Use function code **0x03** 'Read Input Registers' to read.

Possible response in 'Status' register

0	Busy	Processing command.
1	Error	An error has occurred.
2	Ready	Command has been processed successfully.

8.7.3 Control commands for the (internal/external) BMS bus

BMS bus control commands

int/ext BMS-Bus	Register Ext	Register Int	Register Channel	Register Command	Menu text/ Function
INT	1	1-150	0	1	Test Isometer
EXT	1-99				
INT	1	1-150	0	2	Test change over unit (PRC487)
EXT	1-99		0		

int/ext BMS-Bus	Register Ext	Register Int	Register Channel	Register Command	Menu text/ Function
INT	1	1-150	0	3	Test changeover unit (ATICS)/ Start automatic test changeover 1->2 End after time T(test)
EXT	--	--	--	--	
INT	1	1-150	0	4	Start test generator without changeover (ATICS) / Start test generator without changeover
EXT	--	--	--	--	
INT	1	1-150	0	5	Change over to line 1 (ATICS)
EXT	--	--	--	--	
INT	1	1-150	0	6	Change over to line 2 (ATICS)
EXT	--	--	--	--	
INT	1	0	0	7	Reset alarm (all devices) / RESET Alarm (Broadcast)
EXT	1-99				
INT	1	0	0	8	Clear EDS insulation alarm (EDS) / RESET Alarm EDS (Broadcast)
EXT	--	--	--	--	
INT	1	1-150	0	9	Mute buzzer (MK, TM, LIM) / Mute buzzer [for alarm address] (BC)
EXT	1-99		1-192		
INT	1	1-150	1-12	11	Switch channel on (SMO481; PRC487): channel 1: Change over to line 1; channel 2: Change over to line 2 /Switch on relay/switch
EXT	--	--	--	--	
INT	1	1-150	1-12	11	Switch channel off (SMO481) / Switch off relay/switch
EXT	--	--	--	--	
INT	1	1-150	1-12	14	Test (EDS, RCMS)
EXT	--	--	--	--	

8.7.4 Modbus example for control commands

Example: Changeover of ATICS to line 1

The COMTRAXX® device has the address 1 in subsystem 1. An ATICS of internal address 3 is to be changed over to line 1.

Modbus control command

00 02 00 00 00 0F 01 10 FC 00 00 04 08 00 01 00 03 00 00 00 05

00 02 Transaction ID (is generated automatically)
 00 00 Protocol ID
 00 0F Length
 01 Unit-ID (device address of the COMTRAXX® device)
 10 Modbus function code 0x10 (write multiple registers)
 FC 00 Start register

00 04	Number of registers
08	Length of the data
00 01	Value 1 (subsystem address: subsystem 1)
00 03	Value 2 (internal address: ATICS address 3)
00 00	Value 3 (channel address: always has to be 0)
00 05	Value 4 (command)

Modbus response**00 02 00 00 00 06 01 10 FC 00 00 04**

00 02	Transaction ID (is generated automatically)
00 00	Protocol ID
00 06	Length
01	Unit-ID (device address of the COMTRAXX® device)
10	Modbus function code 0x10 (write multiple registers)
FC 00	Start register
00 04	Number of registers

9 Modbus RTU Slave

Modbus RTU Slave is supported from COMTRAXX® version V4.2.0 and higher.



*Support tools that provide comprehensive information about Modbus can be found in the web user interface at **Tools > Service > Modbus RTU***

- *Generate control commands for BMS.*
- *Display information on all available Modbus registers.*
- *Generate Modbus documentation of all available Modbus registers of the connected devices.*

These support tools are only active when the Modbus RTU interface is operated as a slave.

The Modbus RTU interface can be operated in master or slave mode.

- In **master mode**, device information is integrated into the COMTRAXX® system.
- In **slave mode**, the measured values and alarm states of the connected BMS devices are provided.

The detailed Modbus register data and all other information is presented in the support tools listed above.

Configuration of the Modbus-RTU interface

The configuration of the Modbus RTU interface takes place in the menu of the COMTRAXX® device under **Menu > Settings > Interface > Modbus**.

- Configure the mode of the Modbus RTU interface on the COMTRAXX® device (Factory setting: Master).
- If 'Slave' is selected, the following parameters must be set:
 - The COMTRAXX® device must be assigned its own address. It can then be reached under this address via Modbus RTU.
 - 'Send control commands' can be activated. In this way, control commands can be sent to BMS devices (factory setting: Off).

10 SNMP

10.1 Data access using SNMP

The COMTRAXX® device makes all measured values of the Bender system available via the SNMP interface. The SNMP versions V1, V2c and V3 are supported. The trap function can also be used. When an event occurs in the system, a message is automatically generated and sent to the SNMP manager. Up to 3 receivers can be configured.

10.2 Device assignment for SNMP

To use the SNMP function 'Traps' or the individual texts from the COMTRAXX® application, the Bender MIB V2 must be used. It provides these functions. In addition, it is necessary to generate a device assignment for the SNMP image. There, the address of the device on the SNMP side is defined. This can be done automatically or configured individually.

The configuration is done at  > **Device management** > **Device assignment** > **SNMP**. There, the MIB files are also available for download.

11 Troubleshooting

11.1 Malfunctions

If the device causes malfunctions in the connected networks, please refer to this manual.

11.1.1 What should be checked?

Check whether

- the device is supplied with the correct supply voltage U_S .
- the BMS bus cable is correctly connected and terminated (120 Ω).
- the BMS address is set correctly.
- the BCOM address settings are correct.
- the power supply cable to the display is plugged in firmly.
- the video cable is plugged in firmly.
- the USB cables are plugged in firmly.

11.1.2 Frequently asked questions

How do I access the device if the address data are unknown?

1. Connect the device directly to a Windows PC using a patch cable
2. Activate the DHCP function on the PC.
3. Wait around one minute.
4. Access is now possible using the following pre-defined IP address: 169.254.0.1.
5. Now set the new address data.

 Document the new settings as a PDF file. Use the backup function to save all settings of the device (see Chapter: Device features).

Frequently asked questions on the Internet

FAQs on many Bender devices can be found at:

Fast assistance | Bender GmbH & Co. KG

11.2 Device operation, maintenance, cleaning

Device operation

The device can be operated with latex, vinyl and nitrile gloves without impairing functionality.

Maintenance

The device does not contain any parts that require maintenance.

Cleaning

The glass front can be cleaned with common cleaning agents. Glass and seal are resistant to alcoholbased disinfectants.

12 Technical data

12.1 Tabular data

Insulation coordination acc. to IEC 60664-1

CP907-I

Rated voltage	50 V
Overvoltage category	III
Pollution degree	2
Rated impulse voltage	800 V

CP915-I

Rated voltage	AC 250 V
Overvoltage category	III
Pollution degree	2
Rated impulse voltage	4 kV

Supply

CP907-I via plug-in terminal (A1/+; A2/-)

Nominal voltage	DC 24 V SELV/PELV
Nominal voltage tolerance	±20 %
Typical power consumption at DC 24 V	< 15 W
Maximum cable length when supplied via B95061210 (24-V DC power supply unit 1.75 A):	
0.28 mm ²	75 m
0.5 mm ²	130 m
0.75 mm ²	200 m
1.5 mm ²	400 m
2.5 mm ²	650 m

CP907-I via Power-over-Ethernet (PoE)

Nominal voltage	DC 48 V SELV/PELV
Nominal voltage tolerance	-25...+15 %
Typical power consumption for PoE	< 15 W
Maximum cable length when supplied via AWG 26/7; 0.14 mm ²	100 m

CP915-I via terminal block (L1; N)

Nominal voltage via external power supply unit	AC 100... 240 V
Nominal voltage tolerance	-15...+10 %
Frequency range U_5	50...60 Hz
Typical power consumption at AC 230 V	< 30 W

Stored energy time in the event of voltage failure

Time, date	min. 3 days
------------	-------------

Displays, memory

Display CP907-I/Resolution	7" TFT-Touch Display/800 x 480
Display CP915-I/Resolution	15,6" TFT-Touch Display/1280 x 720
E-mail configuration and device failure monitoring	max. 250 entries
Individual texts	unlimited number of texts with 100 characters each
Number of data points for 'third-party devices' to Modbus TCP and Modbus RTU	1600
Number of data loggers	30
Number of data points per data logger	10,000
Number of entries in the history memory	20,000

Visualisation

Number of pages	50
Background image size	max. 3 MB

Interfaces

Ethernet	
Connection	RJ45
Cable	shielded, both ends of shield connected to PE
Cable length	< 100 m
Data rate	10/100 Mbit/s, autodetect
HTTP mode	HTTP/HTTPS (HTTP)*
DHCP	on/off (off)*
t_{off} (DHCP)	5...60 s (30 s)*

Ethernet

IP address	nnn.nnn.nnn.nnn (192.168.0.254)*, always reachable via: 169.254.0.1
Net mask	nnn.nnn.nnn.nnn (255.255.0.0)*
Protocols	TCP/IP, Modbus TCP, Modbus RTU, PROFINET, DHCP, SNMP, SMTP, NTP

BMS bus

Interface/protocol	RS-485/BMS internal
Operating mode	master/slave (master)*
Baud rate	9.6 kBit/s
Cable length	< 1200 m
Cable	shielded, one end of shield connected to PE
recommended	CAT6/CAT7 min. AWG23
alternative	twisted pair, J-Y (St) Y min. 2x0.8
Connection	'ABMS', 'BBMS' (see plug-in terminal)
Terminating resistor	120 Ω (0.25 W), can be switched on internally (see plug-in terminal)
Device address	1...150 (1)*

BCOM

Interface/protocol	Ethernet/BCOM
Cable length	< 100 m
BCOM system name	(SYSTEM)*
BCOM subsystem address	1...255 (1)*
BCOM device address	0...255 (0)*

Modbus

Bender Modbus image	V1, V2 (V2)*
---------------------	--------------

Modbus TCP

Interface/protocol	Ethernet/Modbus TCP
Cable length	< 100 m
Operating mode	client for Bender Modbus TCP devices and 'third-party devices'

Modbus TCP

Operating mode	Server for access to process image and for Modbus control commands
Parallel data access from different clients	max. 25

Modbus RTU

Interface/protocol	RS-485/Modbus RTU
Cable length	< 1200 m
Cable	shielded, one end of shield connected to PE
recommended	CAT6/CAT7 min. AWG23
alternative	twisted pair, J-Y (St) Y min. 2x0.8
Connection	'AMB', 'BMB' (see plug-in terminal)
Operating mode	master/slave (master)*
Baud rate	9.6...57.6 kBit/s
Terminating resistor	120 Ω (0.25 W), can be connected internally (see plug-in terminal)
Supported Modbus RTU slave addresses	2...247

PROFINET

Interface/protocol	Ethernet/PROFINET
Operating mode	slave (IO device)

SNMP

Interface/protocol	Ethernet/SNMP
Versions	1, 2c, 3
Supported devices	query of all devices (channels) possible
Trap support	yes

USB

Number	2
Operating mode	USB-2.0 host (5 V, 500 mA)
Data rate	480 Mbit/s
Cable length	< 3 m
Connection type	USB 2 Standard-A

Used ports

53	DNS (UDP/TCP)
67, 68	DHCP (UDP)
80	HTTP (TCP)
123	NTP (UDP)
161	SNMP (UDP)
162	SNMP TRAPS (UDP)
443	HTTPS (TCP)
502	MODBUS (TCP)
4840	OPCUA (TCP)
5353	MDNS (UDP)
48862	BCOM (UDP)

Digital inputs (1...12)

Number	12
Galvanic separation	ja
Maximum cable length	< 1000 m
Operating mode	selectable for each input: active-high or active-low
Factory setting	active-high
Voltage range (high)	AC/DC 10...30 V
Voltage range (low)	AC/DC 0...2 V
Max. current per channel (at AC/DC 30 V)	8 mA
Connection push-in terminal	(1-1) (2-2) (3-3) ... (12-12)

Switching elements

Number	1 relay
Operating mode	N/C operation or N/O operation
Function	programmable
Electrical endurance under rated operating conditions, number of cycles	10,000
	Contact data acc. to IEC 60947-5-1
Utilisation category	AC-13 / AC-14 / DC-12
Rated operational voltage	24 V / 24 V / 24 V
Rated operational current	2 A / 2 A / 2 A

Minimum contact load (relay manufacturer's reference)	10 µA / 10 mV DC
Connection	plug-in terminal (11;12;14)

Buzzer

Buzzer message	can be acknowledged, adoption of characteristics of new value
Buzzer interval	configurable
Buzzer frequency	configurable
Buzzer repetition	configurable

Audio

Line IN	not used
Line OUT	Output to a STEREO playback device via 3.5 mm jack plug
Cable length	< 3 m

Device connections

Terminal block (L1; N; PE) (for CP915-I only)

Conductor sizes	AWG 20-12
Stripping length	10...11 mm
rigid/flexible	0.5...4 mm ²
flexible with ferrule with/without plastic sleeve	0.5...4 mm ²
Multiple conductor, flexible with TWIN ferrule with plastic sleeve	0.5...4 mm ²

Plug-in terminal (A1/+; A2/-) (11;12;14)

Plug-in terminal (A1/+; A2/-; PE) (11;12;14)

Conductor sizes	AWG 24-12
Stripping length	10 mm
rigid/flexible	0.2...2.5 mm ²
flexible with ferrule with/without plastic sleeve	0.25...2.5 mm ²
Multiple conductor, flexible with TWIN ferrule with plastic sleeve	0.5...1.5 mm ²

Plug-in terminal (I1...I2), (k1...k12), (...MB), (...BMS)

Conductor sizes	AWG 24-16
Stripping length	10 mm
rigid/flexible	0.2...1.5 mm ²
flexible with ferrule without plastic sleeve	0.25...1.5 mm ²
flexible with ferrule with plastic sleeve	0.25...0.75 mm ²

For UL applications (CP907-I only)

Use copper lines only.

Minimum temperature range of the cable to be connected to the plug-in terminals	75 °C
Minimum temperature range of the cable to be connected to the PoE plug	80 °C

Environment/EMC

EMV	IEC 61326-1
Operating temperature	
CP907-I	-10...+55 °C
CP907-I for UL applications	-10...+50 °C
CP915-I	-5...+40 °C
Operating altitude	≤ 2000 m AMSL
Rel. humidity	≤ 98 % at 25 °C

Classification of climatic conditions acc. to IEC 60721

Stationary use (IEC 60721-3-3)	3K22
Transport (IEC 60721-3-2)	2K11
Long-term storage (IEC 60721-3-1)	1K22

Classification of mechanical conditions acc. to IEC 60721

Stationary use (IEC 60721-3-3) CP907-I only	3M11
Stationary use (IEC 60721-3-3) CP915-I only	3M10
Transport (IEC 60721-3-2)	2M4
Long-term storage (IEC 60721-3-1)	1M12

Other

Operating mode	continuous operation
Mounting	display-oriented
Degree of protection, front	IP54
Degree of protection, front, for UL applications	IP50
Degree of protection, enclosure	IP20
Flammability class	UL 94V-0
Dimensions	
CP907-I (W x H x D)	226 x 144 x 78 mm
CP915-I (W x H x D)	505 x 350 x 95 mm
Weight	
CP907-I	< 1.1 kg
CP915-I	< 6.1 kg

(*) = factory setting

12.2 Standards, approvals and certifications



CP907-I only
895061031

12.3 Ordering information CP9...-I

Complete devices

Type	Display size	Supply	Device dimensions (W x H x D), mm	Weight	Enclosure	Display unit	Art. No.
CP907-I	7' (17.6 cm)	DC 24 V, < 15 W	226 x 144 x 78	1.1 kg	Flush-mounting enclosure	Glass, tempered, white	B95061031
			226 x 144 x 65	1.0 kg	Control cabinet door mounting		B95061032
CP915-I	15.6' (38.6 cm)	AC 100... 240 V < 30 W	505 x 350 x 92	6.1 kg	Flush-mounting enclosure		Glass, tempered, grey

Scope of delivery:

- Display unit
- Control cabinet door mounting or flush-mounting enclosure incl. mounting plate with electronics
- CP9...-I connecting cable
- Plug kit

Individual components

Device series	Type	Art. No.
CP907-I	Flush-mounting enclosure	B95100140
CP915-I	Display unit white	B95061090
	Display unit grey	B95061110
	Flush-mounting enclosure incl. mounting plate with electronics	B95061092

Accessories

Device series	Description	Art. No.
alle	CP9...-I replacement plug kit	B95061910
CP915	CP9...-I suction lifter ¹⁾	B95061911
CP907	CP907-I surface-mounting enclosure	B95061915
CP915	CP915-I-surface-mounting enclosure	B22301077

- 1) The suction lifter is required to remove the display of the CP915-I.

12.4 Document revision history

Date	Document version	Valid from software version	State/Changes
10.2020	00	V4.1.x	First edition
11.2020	01		<i>Editorial revision</i> Chapter 4.: Indications PoE connection; Enclosure door installation <i>Added</i> Chapter 12.2: UKCA logo
04.2021	02	V4.3.x	<i>Editorial revision</i> Chapter 12.1: Cable recommendations and lengths, Modbus RTU switchable master/slave <i>Added</i> Chapter 7.: Display description of parameter addresses; new widget logger table
11.2021	03		<i>Added</i> Chapter 4.: Surface-mounting enclosure for CP907-I Chapter 12.3: Ordering details surface-mounting enclosure CP907-I <i>Corrected</i> Chapter 8.: Designation A&T, Modbus examples <i>Removed</i> Internet explorer
12.2021	04	V4.5.x	<i>Added</i> Chapter 4.2: Indications Ethernet and PoE, connections main board Chapter 8. PROFINET
03.2023	05	V4.6.x	<i>Editorial revision</i> Chapter 'Data modules' Wiring diagram <i>Added</i> Chapter 'Modbus-RTU-Slave' Chapter 'Device operation, maintenance, cleaning' Surface-mounting enclosure for CP915-I



Alle Rechte vorbehalten.
Nachdruck und Vervielfältigung
nur mit Genehmigung des Herausgebers.

Bender GmbH & Co. KG
Postfach 1161 • 35301 Grünberg • Deutschland
Londorfer Str. 65 • 35305 Grünberg • Deutschland
Tel.: +49 6401 807-0 • Fax: +49 6401 807-259
E-Mail: info@bender.de • www.bender.de



All rights reserved.
Reprinting and duplicating
only with permission of the publisher.

Bender GmbH & Co. KG
PO Box 1161 • 35301 Grünberg • Germany
Londorfer Str. 65 • 35305 Grünberg • Germany
Tel.: +49 6401 807-0 • Fax: +49 6401 807-259
E-mail: info@bender.de • www.bender.de