

MONITOR

219

Cologne hotel installs
the first version of ebee
charging points

LINETRAXX® VMD460-NA:
New requirements for connecting
power generation systems to the grid



Future
power
needs
reliable
storage



NEW

Additional page "Practical Expertise" at the back of the booklet for collection!
Retrofitting requirement for monitoring devices

BENDER Group

editorial

EDITORIAL

Dear Readers,

Innovation, digitalisation and expansion are the keywords of the latest issue of MONITOR magazine.

Bender's impressive innovative energy is reflected time and time again in the wide range of new products that have reached market maturity, and this year is no exception. These include the new generation of residual current monitoring modules from the SensorPRO series and the new VMD460-NA device for network and system protection that meets the new requirements for connecting power generating plants to the network. The CC612 charge controller, which provides the basis for transparent, kWh-accurate electricity billing in AC charging stations in compliance with German calibration law, is further proof of this. As a company, not only do we keep up with the latest trends in our business fields, but our innovative solutions are also proving themselves around the world on highways, such as the quick charging stations for electric vehicles in Canada, and on the high seas, for example the seagoing customs vessels "Helgoland" and "Borkum", as well as in monitoring energy storage systems.

We continue to develop in terms of digitalisation. We are continually expanding our online communication channels, networking on an international level and providing new and interesting information on LinkedIn, Facebook, XING, Twitter, YouTube and, most recently, Instagram. And this, first and foremost, with the aim of providing customers with direct and simple means of contacting us and making interaction with us easier in this age of digital media usage.

And we are expanding: We have further strengthened our presence in Asia with the acquisition of Eetarp Engineering in Singapore and the integration of this sector in our APAC region, as well as the opening of the Shanghai office. Further steps will follow in order to grow the business on the international market and to provide even better support to customers and partners in the various regions of the world.

Yours sincerely,

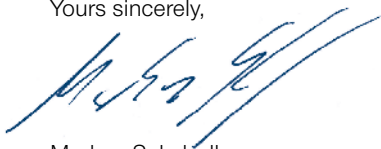

Markus Schyball
CEO



SUBSCRIPTION

Would you like to receive a print version of the MONITOR twice a year and **free of charge?**

Please use the link www.bender.de/monitor-abo or scan the code.



IMPRINT

Bender GmbH & Co. KG.
Londorfer Straße 65
35305 Gruenberg / Germany
Fon: +49 6401 807 - 0
Fax: +49 6401 807 - 259
E-Mail: info@bender.de
www.bender.de

Editorial staff: Marita Schwarz-Bierbach, Daniela Theiß
Graphic & layout: Natascha Schäfer, www.s-designment.net
Copy-editing/text: Michaela Heck M.A., textwerk

Photos: Bender Archiv, SiDesignment Archiv, Stadthotel am Römerturm, Köln, Rotekreuzklinikum München Zoll
Carsten Müller
Capacitor Technologies PTY Ltd, Australien
SPF Engineering Thailand
AdobeStock: pickup, lassedesignen, malp, zentilia, chinnawat, tongpatong, chungking, Ingo Bartussek, FG, orpheus26, IRstone
123RF: skdesign, malp
iStockphoto: num_skyman
Fotolia: danielschoenen
Kroha Fotografie

Print: JD Druck. Lauterbach



Future power needs reliable storage

Page 04

The future belongs to renewables. In order to replace fossil fuels completely without any limitations on comfort and reliability, high-capacity and reliable power storage is required.



New requirements for connecting power generation systems to the grid

Page 20

The steadily increasing number of power generation systems, particularly photovoltaic plants but also combined heat and power plants (CHP), hydroelectric power plants and wind energy which is fed into the grid, but throughout Europe as a whole.



Insulation monitoring system for 24/7 readiness for duty at sea

Page 40

"Helgoland" and "Borkum" – what sounds like a fresh breeze and sea air is concentrated technology designed to ensure safety at sea. They are two seagoing customs vessels from the maritime unit of the German customs authorities and coast guard.

04 Future power needs reliable storage

- 10 **Bender finalist at the eMove360° Award for**
- 12 **Charging points now compliant with German calibration law:** Is calibration law a compliant billing solution for you?
- 14 **Bender China formally opens new office in Shanghai**
- 15 **Battery energy storage systems for energy producers, grid operators and industry**

INNOVATIVE PRODUCTS

- 18 **CTBS25 and RCMB330:** Split-core type B measuring current transformers
- 20 **LINETRAXX® VMD460-NA:** What has changed? – New requirements for connecting power generation systems to the grid
- 24 **LINETRAXX® NGRM500:** NGR monitoring product family has grown
- 26 **COMTRAXX®:** Start of a new generation with a whole range of possibilities

TECHNICAL APPLICATION

- 28 **Stadthotel am Römerturm:** Cologne hotel installs the first version of ebee charging points
- 32 **Bender makes coal seam gas production safe:** Control concept allows insulation and well monitoring side by side
- 37 **Rotkreuzklinikum Munich – Clinic of Gynaecology and Obstetrics:** Retrofit of the operating theatre and the delivery rooms
- 40 **Customs vessels „Helgoland“ and „Borkum“:** Insulation monitoring system for 24/7 readiness for duty at sea

BENDER INHOUSE

- 44 **Are you already online?** If so, you can follow Bender on social media!
- 46 **Bender acquires Eetarp:** Southeast Asia is getting closer
- 49 **Improved safety for the coast:** Offshore – training and surveys – Bender UK enhanced capabilities

AGENTS CORNER

- 50 **SPF Simplify Engineering, Thailand:** We make electrical safety simple

53 EXHIBITIONS 2019/20

- 54 **INTERVIEW** with Ruland Dahnke, Head of Division Marketing & Communication, Bender GmbH & Co. KG
- 56 **PRACTICAL EXPERTISE:** Retrofitting requirement for monitoring devices

FEATURE





Future power needs reliable storage

The future belongs to renewables.

In order to replace fossil fuels completely without any limitations on comfort and reliability, high-capacity and reliable power storage is required. This applies to private solar power systems and electric vehicles, as well as to industrial applications.

An increasing number of private households and companies as well as towns, cities and communities, are using photovoltaic systems. In 2018 alone, 76,500 new systems with a total capacity of 2.95 GWp were installed. This puts the total capacity of photovoltaic systems in Germany at 46 GWp. According to estimates by Bundesverband Solarwirtschaft (German Solar Association), this covers around 8 % of gross power consumption. However, it is not only solar power that makes an important contribution to the power supply.

The number of onshore and offshore wind farms has also risen steadily in recent years and has more than tripled since 2000. In 2018, 743 new onshore wind turbines with a capacity of 2,402 MW and new offshore plants with a total capacity of 969 MW were installed. With more than 30,000 wind turbines installed and a total capacity of nearly 60,000 MW, wind power now ranks second largest for power generation in Germany and is even in front of coal and nuclear power. Despite this, the transition to renewables remains a complex challenge in many areas.

Sluggish grid expansion slows the energy revolution

The first challenge is the relatively large natural fluctuations that renewables are subject to. For example, a photovoltaic system only delivers power when the sun is shining, and a wind turbine only turns when the wind blows. The second challenge is the long electricity transport routes from the decentralised power generation plants. Even the highly efficient offshore wind farms are generally a long way from the places where the power is needed. An appropriately dimensioned grid infrastructure is required to transport electricity efficiently over hundreds of miles. Grid expansion has progressed very slowly in recent years. This is partly because these megaprojects are extremely costly and time-consuming, and partly because the planned route has often led to resistance and protests.





FEATURE

▶▶▶ The problem lies not only in the lack of power lines, but in the existing infrastructure. Many grid connection points are limited physically and therefore do not have the required absorption capacity. As a result, it is not possible to actually feed the entire quantity of electricity, which, for example, could be generated by a wind turbine on a windy day, into the grid. The result: the wind turbine must be shut down, the power remains unused and the efficiency of the plant decreases. In these cases, the use of large-scale decentralised battery storage devices provides a simple and efficient solution for optimising the use of renewable energy. High-performance battery energy storage systems (BESS) are placed as a buffer storage between the wind turbine and the grid connection point. If the grid connection point is running to capacity at any time, the power generated by the wind turbine is fed into the battery storage device and stored there temporarily. If the grid connection point can accept power again at a later time, the battery feeds the power into the grid. In view of the enormous energy density of modern large-scale storage units, it is of course important that they are equipped with all necessary safety facilities.

Another challenge for renewables is the fluctuating power demand and the flexibility required for sudden peak loads or disturbances at individual power plants or other power generators. While wind energy and solar power are well suited to cover the base load, additional power plants need to be available in the short term to quickly provide the energy required when demand peaks occur to prevent a possible blackout. In addition to pumped storage and compressed air storage power plants, modern gas turbine power plants are often used for this purpose.

In the future, modern, high-performance battery storage systems can play an increasingly important role in compensating for the consequences of sluggish grid expansion and covering peak loads. They offer a great advantage over other storage methods:

battery storage systems do not need to transform the energy but can store the power directly and feed it into the grid, which is much more efficient.

Power storage systems for the private energy revolution

Another important application – for storage systems with smaller dimensions, however – can be found in private households with solar power systems. For many years, there was a major problem with this: generally, solar power systems only produce electricity during the daytime, and therefore, at times when the power demand in private households is relatively low, because it is sunny and many people are at work. Thus, the economically interesting domestic consumption rate remains limited. Existing storage solutions were limited in their capacity and, moreover, disproportionately expensive. This has changed significantly in recent years. With increased storage capacity, the price of solar home and commercial storage has halved in the last four years. As a result, the majority of planned new solar power systems are currently equipped with powerful lithium batteries. These store the electricity produced during the day and make it available during the evening and at night. In order to ensure uninterrupted power supply, an increasing number of these private battery storage devices are currently also being equipped with an emergency power system which, depending on the design, will cut in immediately or following a short delay if the public power grid fails.

The compact battery storage devices installed in private households considerably increase the domestic consumption rate and the efficiency of solar power systems. At the same time, they can play a role in the further dissemination of electric

"In view of the **enormous energy density of modern large-scale storage units**, it is of course important that they are equipped with all necessary safety facilities."



vehicles. Because here, too, solar power systems supply electricity during the day when users are at work with the car and not, as needed, in the evening or at night when the car is in the garage and can be charged. In addition, thanks to their high energy density, modern battery storage systems can meet the power requirements of high-performance **fast-charging stations**, which is not generally possible using a conventional solar power system.

Storage systems secure availability

In our modern, digital world, power is simply indispensable. For example, in places where power failures have serious consequences, such as in hospitals and other healthcare facilities. In order to avoid the risk to life and limb that a blackout could mean, these facilities are equipped with efficient emergency power supplies. But even in many industrial processes as well as in research and science, uninterruptible power supply is enormously important. For example, in the chemicals and paper industries, where power failures can lead to the destruction of entire production batches,

or in companies where a disruption of the cold chain spoils products and thus causes great financial damage. Safe, powerful and reliable battery storage systems can therefore make an important contribution to uninterruptible power supply systems.

Other important applications for industrial-scale storage can be found internationally, especially in structurally weak regions without adequately developed grids. Here, it can be quicker and more economical to not invest in the expansion of the existing power grid, but instead to develop remote areas using a decentralised power supply. To do this, a photovoltaic system, for example, can be combined with powerful, sufficiently dimensioned and turnkey battery storage units. This stand-alone electrical solution can then reliably supply either a company or an entire location – irrespective of the remote power grid – and positively influence the development of an entire region.





FEATURE



The natural fluctuations in the power generated by renewable energy sources require high-capacity and secure storage solutions.

Intelligent peak load management lowers electricity costs

In view of steadily rising electricity prices, energy costs are an important factor for a company's profitability, and thus its success. This is especially true for industries employing energy-intensive processes and simultaneously fluctuating energy requirements. For many industrial consumers, the electricity price is determined on the basis of registered power measurement (RLM). The utility companies measure the peak load over a measurement duration of 15 minutes and derive the electricity price from it. This means that a company's peak load determines the price they pay for electricity with the result that even a single, short-term electricity peak can push the price for electricity up for the entire quarter or year. Electricity suppliers use this electricity peak to derive the demand, which they must constantly supply. Power provision of this kind costs money and is factored into the electricity price accordingly.

For companies this means: the lower they can keep their power peaks, the lower the electricity price and thus the electricity costs. At this point, high-performance commercial or industrial storage systems can perform an important service and cap the peak load by means of what is known as peak shaving, by relieving the load on the customer's side. They thus offer an alternative and a supplement to common load management, in which individual loads are switched off in the event of an imminent peak load. Industrial or commercial storage systems are integrated into the company's power grid and can be charged by an in-house PV system or by the utility's power grid during periods of low energy demand. If there is a risk of



NEWSWORTHY



Bender finalist at the eMove360° Award for

Electric & Autonomous Mobility: Award for innovative solutions

The awards ceremony for the fourth Award for Electric & Autonomous Mobility 2019 took place on 14 October 2019 in the Gloria Filmpalast in Munich on the eve of the world's largest international trade fair for electromobility. This year, 23 finalists from seven countries were nominated for the award. Bender's charge controller from the CC612 series was nominated as a component of AC charging stations for electric vehicles in the category Energy & Charging and was also part of the award winners in other ways.

"We are very pleased that the eMove360° Award for Electric & Autonomous Mobility, just like our exhibition, is growing continuously. Many of this year's submissions, especially those from the award-winning companies, address the big issues raised by the transition from fossil fuels to new mobility in a very practical and solution-oriented way", stated Robert Metzger, Managing Director of the MunichExpo and organiser of the eMove360° Award, at the award ceremony in Munich. Besides new technologies, numerous companies from all over the world produce intelligent and, above all, economically viable concepts which convinced the expert jury.



The winning team in the category "student":
The Swiss University of Applied Sciences ETH Zurich

Concepts for e-mobility of tomorrow

The prizes were awarded in the categories Mobility Concepts & Software, Charging & Energy, Battery & Powertrain, Automated Driving & Electronics as well as Light Electric Vehicle and Electric Passenger Car. Among the award winners were Future Mobility Solutions from Gaimersheim near Ingolstadt, Germany, with an innovative simulation and virtualisation tool for municipal urban and transport planning and Webasto from Stockdorf near Munich, Germany, with a charging solution in private and semi-public spaces. Furthermore, the engineering service provider EDAG from Fulda, Germany, received an award for its scalable battery concept, the US software company Aurora Labs for its self-healing software, the Berlin-based e-mobility start-up UNU Motors for its new e-scooter and Jaguar with its electric SUV I-PACE. Marco Job, a student at ETH Zurich, accepted the special prize for student submissions on behalf of a large team of students from this renowned Swiss university.

Share of special prize and other contributions presented

Bender is proud that a number of participants, including finalists and winners, are installing various products from the Bender e-mobility product range in their presented solutions within the seven categories of the award.

For example, the winner of the Student Award, a development team from ETH Zurich for a two-wheel-driven electric motorcycle. Since 2017, Bender has been supporting the motorcycle project in the context of the Formula Student Sponsoring with an IR155-3204 insulation monitoring device, and thus indirectly became part of the special prize.

Charge controller among the finalists

Bender had submitted the smart charge controller of the CC612 series as central components of AC charging stations for electric vehicles specifically for this competition and reached the finals in the Energy & Charging category. The intelligent charge controller uses technical and functional innovations in order to simplify the setup of a comprehensive Plug&Charge charging infrastructure that conforms to the German calibration law and enables new business and billing models.

The charge controllers were developed in close cooperation with ebee smart technologies, a Bender subsidiary. After the second generation, which is successfully in use, the charge controllers of the third generation will be available by the end of 2019 with further extended functionalities (e.g. Ethernet, emergency release). ■

Michaela Heck M.A., textwerk



A look
inside
of a charging
station

NEWSWORTHY

Is calibration law a compliant billing solution for you?

Charging points compliant with German calibration law now available with Bender CC612 charge controller as basis

Solutions compliant with German calibration law are intended to provide clarity and guarantee kWh-accurate billing when charging electric vehicles. This was the aim of the S.A.F.E. initiative launched by the Physikalisch-Technischen Bundesanstalt (PTB). Following the issuance of a type-examination certificate, charging point manufacturers are able to provide billing in compliance with German calibration law.



Transparency software



Energy meter



Compliant with German calibration law





The choice of charge controller is a fundamental decision for each charging station, since it is the core element which decisively influences the function of the charging station. With its intelligent CC612 charge controller, Bender offers the basis for an AC charging station or wallbox which not only stands out for its cost-effectiveness and safety, but also allows for the construction of a charging infrastructure that complies with German calibration law.

The technical basis for billing in compliance with German calibration law is provided via the combination of the CC612 charge controller, the energy meter developed by EMH, and the transparency software. The manufacturer-independent transparency software solution offers simple, transparent kWh-accurate billing of electricity for technical operators of charging infrastructure (CPO), backend operators and end customers. The CPO is not forced to commit to a proprietary solution or predetermined combination of charging point hardware and backend. Billing in compliance with German calibration law is legally required not only for the public spaces, but also for charging company vehicles at private domestic connections with subsequent reimbursement by the employer as required by law.

Two Bender partners, the two former start-ups ebee smart technologies GmbH from Berlin and Wirelane GmbH from Munich, who have installed the CC612 charge controller in conjunction with the EMH energy meter and transparency software, have been awarded a type-examination certificate for their charging station and are now calibration law-compliant. ■

*Dipl.-Betriebsw. Marita Schwarz-Bierbach, Marketing & Communication
Dipl.-Ing. Frank Mehling, Business Unit Emobility*



S.A.F.E Initiative

S.A.F.E. (Software Alliance for E-mobility) initiative, which was originally founded in 2017 by the Physikalisch-Technischen Bundesanstalt (PTB), has already been joined by 30 companies, including several charging station manufacturers, e-mobilists, charging point operators (CPO), e-mobility providers (EMP), manufacturers and authorities. The "S.A.F.E. e. V. – association for the promotion of research and consumer protection in the field of electromobility"¹⁾ has also been established as a result of this initiative.

The aim of S.A.F.E. is to make the charging of an electric vehicle at the charging station legally secure (in compliance with calibration law). The key topics are:

- **the encryption in the counter**
- **a transparency software**
- **the type-examination certificate.**

The Austrian company has.to.be and ebee Smart technologies from Berlin, a subsidiary of the Bender Group, have been commissioned with the development of the transparency software. This manufacturer-independent transparency software is available to everyone in a non-discriminating manner at www.transparenz.software. The transparency software has been officially certified and available from VDE since spring 2019.

Benefits of the transparency software:

- Customers receive a transparent and forgery-proof invoice.
- Manufacturers of charging stations use them to carry out conformity assessment procedures.
- This enables the calibration authorities to carry out their calibration checks with absolute certainty.

¹⁾ <https://www.electrive.net/2019/05/12/eichrecht-initiative-s-a-fe-organisiert-sich-als-verein/>



NEWSWORTHY

Bender China formally opens new office in Shanghai

Opening a new office in Shanghai, the heart of China's business centre, Bender China has achieved the next step for growing the business in the Chinese market and giving its customers and partners better support.

Grant Jin, Managing Director of Bender China, Matthias Schwabe, Regional Manager of APAC, and the whole of the Bender China team welcomed selected partners and distributors from different market segments, such as hospital, railway, oil & gas, shipping, nuclear power and e-mobility, at the new premises in the Prona Business Plaza building.

In keeping with Chinese traditions, the red ribbon was cut at exactly 10:18 a.m. and the official opening was announced. Matthias Schwabe from Bender China presented a picture of the whole Bender team in front of the Grünberg HQ office with the signatures of the management and the board of directors, which will be placed in the new office. There was also a video message from CEO Markus Schyboll with greetings from the management and the Bender family.

Afterwards, the structure of the organisation with its managing heads Grant Jin (BU e-mobility) and Wei Zhou (Industry and Hospitals) and the future growth plans and the organisation were presented to the guests by Grant Jin and Matthias Schwabe. In future, all business segments, especially the business units Hospital, Industrial and e-mobility Solutions, will be further promoted in China. The Bender family are fully behind the team in China and support it. Employees from China will come to Grünberg to exchange experiences and receive intensive training in all Bender products. Direct contact between the new and centrally located sales office in Shanghai and the head office will be further intensified to better meet future challenges and the needs of Chinese customers. The size of the country with more than a billion people, rising living standards and the huge investment make China the most important foreign market for Bender along with the US. ■



*Anna Hopfinger, B.Sc.
Marketing & Communication*

Setting the agenda for system design

– high availability and improved fire protection

Battery energy storage systems

for energy producers, grid operators and industry



Nowadays, battery energy storage systems are making a major contribution to electromobility, (stand-alone) power systems in remote areas, the integration of renewable energies, the optimisation of energy use and grid system services. Reduced system and technology costs, particularly with lithium-ion batteries, are encouraging this development as an alternative to conventional storage technologies such as pumped storage hydro power stations.

Two types of major industrial battery energy storage systems have been developed for energy producers, industry and grid operators. The first consists of freely planned battery energy storage systems used in buildings or halls whilst the second offers turnkey container solutions. These application-dependent battery energy storage systems stand out thanks to their high energy storage capacity (kWh - MWh) or high performance capacity (≥ 500 kW). They are also characterised by the use of a transformer for grid connections.



▶▶▶ **Close up:**
High availability and fire protection

Power generation, transmission and distribution systems undoubtedly create an important infrastructure on which the economy in general as well as industry, public facilities and private households in particular rely. Battery energy storage systems are used as one of the essential system services in these critical infrastructures where peak load management and frequency control are used. They also provide renewable energy generating plants with more of the accessible features of conventional production technology. This guarantees and significantly improves predictability which without storage technology would not always be possible.

System availability therefore also depends on the availability of the battery storage systems used. A key criterion for battery storage systems is therefore their high availability.

The system's fire resistance capability is directly linked to the amount of energy stored in a lithium-ion battery. The higher the energy content, the greater the likelihood of a large and persistent fire. Once a fire has started, it will generally only go out when the stored energy has been consumed or released. A fire can be caused by an electrical, mechanical or thermal fault.



Manufacturers of battery storage systems are therefore quite justified in establishing fire protection precautions and are constantly looking for new or improved fire prevention solutions.

Other areas of use

It is not just with battery energy storage systems that high availability and fire protection are the focus. In several other long-established branches and applications, high availability and fire protection are equally important.

Examples include hospitals, chemical and processing industries, paper and wood processing, mining, railway signalling equipment, data centres, automation and control circuits. When setting up the electrical supply system, an unearthed system (IT system) is used.

Setting the agenda
in system design

In order to benefit from the inherent advantages of an unearthed IT system, such as high availability and improved fire protection, it must be worked into the system design from the outset. This planning decision is simplified by the fact that the use of a transformer is possible in industrial battery energy storage systems due to high performance (e.g. ≥ 500 kW) or the connection to a higher voltage level. This means that the battery energy storage system is galvanically separated from the system. Furthermore, the DC circuit between the battery and the converter is generally designed as an unearthed system.

Fig. 1

Schematic layout of a battery energy storage system

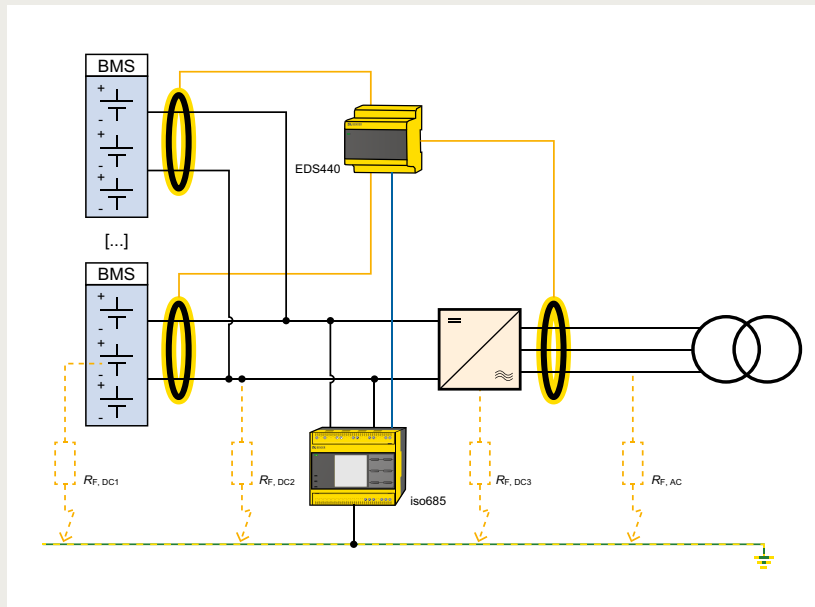

Figure 1 shows the simplified schematic design of an industrial battery energy supply system consisting of the key components of battery/batteries, battery management system (BMS), converter and transformer. All yellow components relate to the monitoring technology. Battery modules are connected in series and combined in racks. The series connection leads to a higher system voltage. The parallel connection of several racks increases performance and storage capacity.

The three-phase converter is responsible for the bidirectional conversion of energy (DC \leftrightarrow AC) and along with the battery is a decisive element in terms of the power flow and performance.

As well as the core components, figure 1 also shows the possible location of earth faults.

Earth faults can occur in the AC circuit between the converter and the transformer ($R_{F, AC}$), in a cell or battery series connection ($R_{F, DC1}$), in the DC circuit between the battery and the converter ($R_{F, DC2}$) and in the DC intermediate converter circuit ($R_{F, DC3}$).

The first fault in an IT system creates a connection to earth. Depending on the fault value and the insulation level, the phase-to-earth voltage of the faulty conductor decreases on the one hand and the phase-to-earth voltage or voltages of the healthy conductors increase on the other hand. In the extreme case of a dead fault (0Ω), the voltage drops to around 0 V and the voltage increase corresponds to the phase voltage. Due to the absence of

the earth connection, no current-carrying circuit can be created after the first fault.

Improved fire protection can be obtained compared with an earthed system by not allowing a residual current to flow after the first fault. An impulsive load on the battery with a high residual current, even if it is only applied for a short time, can therefore be avoided in a battery energy storage system.

High availability is guaranteed as the system does not shut down after the first earth fault. The IT system can in theory still be operated until the second fault occurs. In practical terms, this time advantage is used to detect the insulation fault during ongoing operation, for example by means of insulation fault location technology, so that it can be removed during planned proactive maintenance.

For industrial battery energy storage systems, Bender offers the ISOMETER[®] iso685, which is suitable for the IT system and required by the applicable standards, as well as insulation fault locators such as the ISOSCAN[®] EDS440. ■

Dipl.-Wirtsch.-Ing. Tobias Weiberlenn,
Business Unit Industrial Solutions

INNOVATIVE PRODUCTS

Sensor PRO
CTBS25 and RCMB330

Split-core type B measuring current transformers



Market-driven solutions for modern applications

The requirements placed on industrial systems and installations in terms of high availability are constantly increasing. This means that it is also becoming increasingly important to equip existing applications with monitoring technology so that downtimes can be reduced, for example by assisting with preventive maintenance. Options include installing residual current monitoring systems (RCMS), which also contribute to a reduction of the disconnection times required for insulation tests in line with DGUV (German Social Accident Insurance) Regulation 3.

These systems usually result in a need to install so-called measuring current transformers in the installation; to do this, the feeder cable often needs to be disconnected so that it can be routed through the current transformer. The installation always needs to be switched off for this to be done – which is not really an option for high-availability existing installations.

One solution for this are split-core measuring current transformers, which have been available from Bender for many years – at least in the field of AC and pulsed DC sensitive measuring current transformers. These components can be installed retrospectively with ease in existing installations.

However, since nowadays almost every installation includes non-linear loads and therefore the residual current can potentially contain DC components, there is a growing demand for AC/DC sensitive residual current monitoring systems. Based on this development and the increasing importance of high availability, more and more split-core AC/DC sensitive current transformers are required, which can be installed without disconnecting the installation and can be used for reliable monitoring of the system – even with existing DC fault currents.

Modular devices with new features

The split-core type B series updates and expands Bender's portfolio in the field of residual current monitoring and measuring current transformers with new sensors and devices for measured value acquisition and evaluation. For the first time, Bender now also offers AC/DC sensitive measuring current transformers that are foldable and can therefore be retroactively installed without any problems on permanently installed cables.

The new devices come in two different versions: as a CTBS25 sensor variant for connection to an external evaluator (e.g. RCMS460 or EDS440), and as an intelligent RCMB330 device with an integrated evaluator. The RCMB330 includes evaluation of the RMS value of the residual current, which is provided as a standard feature on Bender RCM devices. However, at the same time it is also possible to evaluate the AC and DC components separately. In addition, the intelligent, split-core current transformer includes the bulk of the new features of the SensorPRO series, such as AC/DC sensitive residual current measurement up to 100 kHz, extended possibilities for filtering and an RS-485 interface with Modbus RTU for reading out the measured values and for parameterising the devices.

At the market launch the new split-core measuring current transformers will initially be offered with an internal diameter of 25 mm. However, other sizes are expected to follow soon if the series is well received. The devices are supplied with DC 24 V, which means that either a voltage supply already present in the installation is used, or a simple standard industrial mains power supply can be used.



Solutions for retrofit applications

With the split-core devices, Bender will now be offering smart, single-channel solutions that come with the huge advantage of allowing simple installation in existing systems: fold open the current transformer, route around the conductors, close again and wire the interface – done! The installation does not need to be switched off for this. And there is no need for the lengthy process of disconnecting the cables. The standard Modbus interface enables connection to higher-level systems such as a PLC, with which continuous monitoring can be implemented. Extensive frequency filter options for the wide frequency range up to 100 kHz support the analysis of leakage and residual currents in the installation. As a result, better conclusions can be drawn about sources of fault.

With the features of the SensorPRO series, the open communication and the split-core design, the sensors offer a high degree of flexibility and are thus future-proof for use in the vast and diverse range of modern applications. ■

*Jan-Nils Lohrey, M.Sc.
Business Unit Industrial Solutions.*

INFO

More information: <https://www.bender.de/en/sensorpro>





INNOVATIVE PRODUCTS

New requirements for connecting power generation systems to the grid

What has changed?

The steadily increasing number of power generation systems, particularly photovoltaic plants but also combined heat and power plants (CHP), hydroelectric power plants and wind energy which is fed into the grid, are of increasing systemic importance not only in Germany but throughout Europe as a whole.

Ensuring of grid stability and the associated reliable power supply places increasing demands on renewable energy plants (RE plants) and determines the technical requirements for their connection to the power grid. Therefore, in future they no longer simply need to be better integrated into the grid, they also need to be able to support the latter in the event of temporary disturbances.

New application rules obligatory since the April 2019¹⁾

In 2017, the Network Code “Requirements for Generators” (RfG)²⁾ was published and implemented at European level. The RfG harmonises the grid connection conditions and the requirements for power generators at all voltage levels thereby creating a standardised framework for the whole of Europe. It pursues technical as well as economic goals. On the one hand, it focuses on maintaining grid stability and integrating RE plants more successfully. On the other hand, a more efficient use of networks and resources Europe-wide strengthening of the markets for generation technologies, increased competitiveness and electricity trading in the EU`s internal energy market are the objectives.

¹⁾ VDE | FNN - Anwendungsbeginn und Übergangsfristen [...] vom 28.01.2019

This does not include so-called existing systems for which a construction permit was requested before 27.04.2019 or, if no construction permit was required, a grid connection was requested. In this case, commissioning must be completed by 30.06.2020.

²⁾ <https://www.vde.com/de/fnn/themen/europaeische-network-codes/rfg>



Changes according to VDE-AR-N- 4105:

1. Dynamic network support

The RfG is being implemented at the national level within different countries where there may be scope for concretization and expansion.

In Germany, the implementation was carried out by the VDE Network Technology/Network Operation forum (abbreviated to: VDE|FNN) with the VDE application rules VDE-AR-N 4105:2018-11 (low voltage), VDE-AR-N 4110:2018-11 (TAR medium voltage), VDE-AR-N 4120 (TAR high voltage)¹⁾ and VDE-AR-N 4130 (TAR maximum voltage)¹⁾. The VDE-AR-N 4110 replaces the German BDEW Medium-Voltage Directive. For the first three of the above-mentioned application rules, the transitional period expired on 26 April 2019.

In the United Kingdom (UK) and Ireland, implementation was carried out by the Energy Networks Association (ena) with the Engineering Recommendations (EREC) G99\1 and G98\1. G99 replaced the G59 and the G98 replaced the G83. The transition period for both ERECs ended on 27 April 2019.

The RfG changes the classification and differentiation of power generation systems and the requirements placed on them. Previously, a distinction was generally made according to the voltage level to which the grid connection was made. Since April 2019, the output of the generation system has been decisive.

Systems with an output $P < 135$ kW must be designed according to VDE-AR-N 4105. For systems with $P \geq 135$ kW the VDE-AR-N 4110 applies. Power generation systems with $P > 50$ kW now also contribute to maintaining grid stability with dynamic grid support. Systems with lower outputs are excluded from this, however.

Dynamic grid support means that in future new power generation systems will remain on the grid in the event of temporary voltage drops or increases instead of switching off as before. This prevents unintentional disconnection in such situations. Because of the growing number of power generation systems, the simultaneous disconnection of several systems would endanger grid stability.

Depending on the voltage drop or increase, a power generation system must remain on the grid for different lengths of time but always for a maximum of 3 seconds (see fig. 1). A voltage dip also affects all the other devices, for example the coupling switches, if there is no buffering. Steps must therefore be taken to ensure that this does not switch off automatically during dynamic grid support. Otherwise dynamic grid support cannot be guaranteed.



Figure 1

Fault-ride-through limiting curves for the voltage characteristics at generator terminals for a type 2 power generating unit and storage Source: VDE-AR-N 4105:2018-11

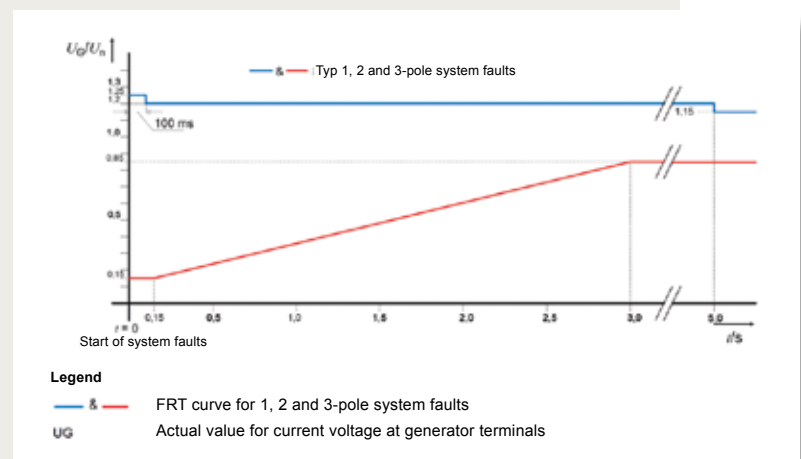

¹⁾ <https://www.vde.com/de/fnn/themen/europaeische-network-codes/rfg>

INNOVATIVE PRODUCTS



Dynamic grid support may and can be limited by anticipating network and system protection. The response values for voltage protection functions are crucial in this context. Unless otherwise agreed with the grid operator, this is the case with the default settings required for voltage drop protection $U \ll$.

2. Network and system protection (NS protection)

NS protection has a central role to play. Central NS protection should therefore be provided for power generation systems whose P is ≥ 30 kW. NS protection is intended to protect the grid and the system against unauthorised operating conditions in terms of voltage and frequency. It may also help to identify island grids. If such an operating condition occurs, the NS protection disconnects the power generation system from the grid by switching off

the coupling switch. Essentially this prevents feeding into or supporting an island grid.

The amended set values in table 1 apply for NS protection and its protective functions. Only a few other values can be adjusted.

In addition, the central NS protection monitors the switching operations of the coupling switch by means of contact feedback. In general, both the switch-off circuit and the contact feedback (NS protection – coupling switch – NS protection) are designed with an undervoltage release or a permanently applied control voltage.

The central coupling switch may now be simplified with only one switching device. In order to ensure single fault safety, the integrated coupling switches should then be integrated into the

Table 1

The amended set values for the protective functions of NS protection,

Source: VDE-AR-N 4105:2018-11

Protective function	Stirling generators, Fuel cells		Directly coupled synchronous and asynchronous generators with $P_n > 50$ kW		Inverters	
	Synchronous and asynchronous generators with $P_n \leq 50$ kW, coupled directly or via inverter					
Rise-in-voltage protection $U >>$	$1,15 U_n$	≤ 100 ms	$1,25 U_n$	≤ 100 ms	$1,25 U_n$	≤ 100 ms
Rise-in-voltage protection $U >$	$1,10 U_n$	≤ 100 ms	$1,10 U_n$	≤ 100 ms	$1,10 U_n$	≤ 100 ms
Voltage reduction protection $U <$	$0,8 U_n$	≤ 100 ms	$0,8 U_n$	1,0 s	$0,8 U_n$	3,0 s
Voltage reduction protection $U \ll$	not applicable		$0,45 U_n$	300 ms	$0,45 U_n$	300 ms
Frequency reduction protection $f <$	47,5 Hz	≤ 100 ms	47,5 Hz	≤ 100 ms	47,5 Hz	≤ 100 ms
Frequency increase protection $f >$	51,5 Hz	≤ 100 ms	51,5 Hz	≤ 100 ms	51,5 Hz	≤ 100 ms

New or changed
Adjustable



switch-off command chain of the NS protection. Bender currently offers the appropriate solution in this context with the LINETRAXX® VMD460-NA NS protection.

Well equipped with the VMD460-NA

The VMD460-NA is intended to protect the grid and the power generation system against unauthorised operating conditions and to disconnect them in the event of limit value violations by controlling coupling switches. The VMD460-NA has therefore been developed according to the principles of single-fault safety. If the activation conditions or (repeat) switch-on conditions have been fulfilled, the VMD460-NA once again releases the connection between the power generation system and the grid.

The VMD460 is easy to configure and serves a wide range of applications resulting from system and country-specific requirements. The corresponding parameters are stored in basic predefined programs in the device. ■

Dipl.-Wirtsch.-Ing. Tobias Weiberlenn, Business Unit Industrial Solutions

Network and system protection VMD460-NA

Benefits for users

Safe

- Built-in single fault safe
- Contact monitoring in coupling switches
- Permanent monitoring of all required electrical measurement parameters
- Password protection

Flexible

- Preconfigured profile for country-specific requirements
- Can be used universally for all decentralised power generation systems

Compliant with standards

- VDE-AR-N 4105: 2018-11
- VDE-AR-N 4110:2018-11
- G99/1-4:2019
- G98/1-4:2019
- CEI 0.21
- BDEW directive
- C10/11, G59/2, G59/3, G83/2, G83/3
- DIN V VDE V 0126-1-1

User-friendly

- Graphic display
- Simple, quick configuration using basic preconfigured program
- Integrated test and simulation functions to determine the shutdown time
- Language selection (German, English)
- Data storage with time stamp

INFO

More information: https://www.bender.de/en/products/measuring-and-monitoring-relays/linetraxx_vmd460-na



INNOVATIVE PRODUCTS

LINETRAXX® NGRM500

NGR monitoring product family has grown



Continuous monitoring of the grounding resistance with NGRM500

In 2017, Bender presented a new global benchmark for monitoring the grounding resistance (NGR) in HRG systems (high resistance grounded systems) with the NGRM700. This benchmark has since been successfully launched on the market and is being continually optimised.

Bender expanded its portfolio even further in 2019 by an additional device for monitoring the grounding resistance: the NGRM500, the new mid-range device in the Bender NGR monitoring product family.

Graphic of three common grounding methods

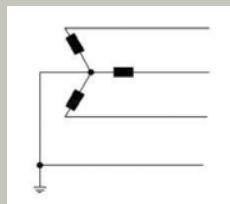

Solidly Grounded

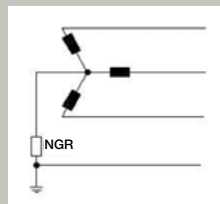

Resistance Grounded

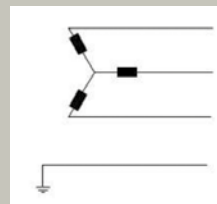

Ungrounded

The measuring technology of the NGRM500 is technologically just as powerful as the NGRM700. Devices of the 500 series can therefore also be used with AC- and DC-sensitive measuring technology for the analysis and safe operation of the most modern types of load in a resistance grounded system. The harmonics analysis of the residual currents with the associated freely configurable evaluations in the frequency range for the response values, which was first presented for the first time in the NGRM700, were also implemented in the NGRM500. They can be used for both notification and analysis purposes. In order to fulfil the plant operator's requirements, the Bender NGR monitors check the active and passive resistance as well as the current and voltage in the NGR.

The limit values can be individually set according to customer-specific requirements and/or in accordance with regional regulations and specifications. This can be carried out as usual either directly on the device or via the standard web server included. The server provides faster access to the data as well as the possibility of carrying out initial analyses without the need for external software. All the data can be read via Modbus depending on the complexity of the plant, the available infrastructure and the operator's preferences.

The combination of the POWERSCOUT® data management system and Bender COMTRAXX® system technology results in a comprehensive monitoring system. The information collected on the status of the installation provides the

		222	227
		 LINETRAXX® NGRM500	 LINETRAXX® NGRM700
Page		222	227
Specific application		Grounding resistance – monitoring (NGR-Monitoring)	Grounding resistance – monitoring (NGR-Monitoring)
Residual currents	System type	■	■
		■	■
		■	■
Phase monitoring L1, L2, L3			■
System voltage L-L*		600 V... 25000 V	600 V... 25000 V
Harmonic analysis	RMS 0...32	■	■
	Spectrum analysis	■	■
Operating mode relay		Configurable N/C operation or N/O operation	Configurable N/C operation or N/O operation
Communication		Web server, BCOM, Modbus RTU, Modbus TCP	Web server, BCOM, Modbus RTU, Modbus TCP
Maximum range of use		2000 m	5000 m
Installation	Removable HMI for front panel installation		■
	DIN rail	■	
	Screw mounting		■

* Freely configurable in device taking suitable coupling devices into account

Figure 1: Extract HK 2020

basis on which the operator can ensure trouble-free operation at all times. This kind of permanent monitoring enables preventive maintenance through early indication of gradual changes and defects. The comprehensive database reduces the scope and cost of regular inspections.

Not only do both devices in the Bender NGRM range offer “state of the art” performance, they also underscore Bender's claim to provide resilient, flexible and intelligent measuring devices. They support the optimisation of plant operations irrespective of the type of system used. ■

*Torsten Epkes, B. Eng.
Business Unit Industrial Solutions*

INFO

More information: <https://www.bender.de/en/know-how/technology/high-resistance-grounding-system-hrg>



INNOVATIVE PRODUCTS

COMTRAXX® COM465IP

Start of a new generation with a whole range of possibilities



UPDATE
available from
January
2020

The functional range of all COMTRAXX® devices is optimised **with the update to V4.00**. It has never been so easy to monitor, control and display the Bender system with the condition monitor and its integrated gateway in such a personalised manner.



The COMTRAXX® software, which is the basis for COM465xx, CP700 and CP9xx devices, has always stood for intuitive use and a perfect overview of the Bender system. Functionality has been significantly expanded with the V4.00 update making for an even broader range of application scenarios. The innovations available with the new version are outlined below:

- New visualisation with many new functions
- A new bus overview: The display can be structured according to subsystems as before or based on interfaces as a new feature.
- Individual texts: Import and export possible. This allows texts to be conveniently exported to Excel, edited there and then imported back into the device.
- Modbus figure V2 was integrated. This makes it easier to access the device data. It is possible to choose between the old figure V1 and the new figure V2.
- Modbus bus cycle time considerably improved
- Support of all current Bender devices
- Silverlight application has been removed as it is no longer supported by Microsoft. The visualisation can therefore be operated directly in any Web browser without plug-ins. All features are integrated in the HTML5 based interface.

Individual and configurable visualisation

The new solution integrates perfectly into the existing COMTRAXX® application. It is simply configured and displayed in the web browser without any additional plug-ins. This is guaranteed by the HTML5 base. The heart of the product is the new editor. This allows the visualisation to be created individually. Up to 50 dashboards can be generated, which are completely freely configurable. A library - full to bursting with different widgets - is available, for example, to display information from measuring points or to execute switching functions.

Additional representation by interfaces

Until now COMTRAXX® has always been presented in the form of subsystems. All the devices connected to the COMTRAXX® device were grouped together in a fixed address range. This view can still be selected. The display by interfaces has now also been added. It is easy to change between the two views. Each interface now has access to its own address range (1-255) thanks to a fundamental reconfiguration of internal addressing. This means that there can no longer be any address collisions between two devices with different interfaces but the same address. It also provides greater clarity for the address structures. From now on additional devices incorporated in the system via measuring devices which have their own interfaces will be properly displayed.

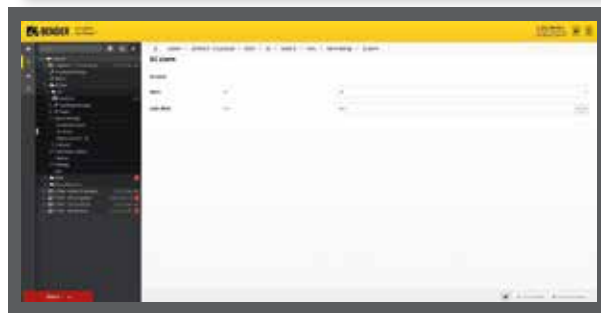
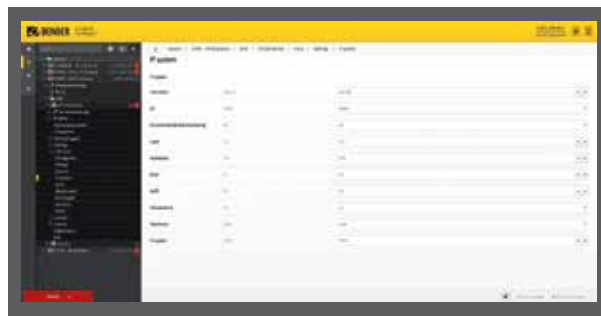

Reduced bus cycle times – faster response

Bus cycle times could be significantly reduced by the internal reconfiguration of the module. This varies depending on the size of the installation but is 10 times faster on average. A rapid response is therefore guaranteed in the case of an alarm which includes all connected Modbus devices. This has also been the case with the COMTRAXX® system. ■

*Jan Hofmann, PGM Product Management
Dipl.-Ing. Joachim Wagner, PGM Division Management*

INFO

More information: <https://www.bender.de/en/products/communication-overview>



Cologne hotel installs

the first version of ebee charging points in compliance with German calibration law

The internationally increasing importance of electric mobility has led to increasing sales of Bender technology for charging infrastructure. With its versatile combination of technical features, the charge controllers from Bender are on their way towards international market leadership. Also in Germany more and more charging points with Bender technology are being installed. In July of this year, the Cologne City Hotel at the Roman Tower put two wallboxes from the Bender subsidiary ebee smart technologies GmbH into public operation.



The e-mobility sector is now gaining momentum in Germany too. Although the Chancellor's goal of having 1 million electric vehicles registered on German roads by 2020 is no longer achievable, according to current estimates, there will be 3 million registered electric vehicles by 2025. In the meantime, the regulatory and economic importance of this topic has dawned on the relevant players: Municipalities are integrating e-mobility concepts into their emission reduction programmes, the property sector is integrating charging infrastructure into their redevelopment and construction project plans. The catering industry is also increasingly recognising the added commercial value of public charging points on their own car parks.

On 22 July of this year, the Cologne City Hotel at the Roman Tower put into public operation two 22-kW wallboxes from the manufacturer ebee smart technologies GmbH. People are paying for public charging either with charging cards from the green electricity supplier Naturstrom and many other providers or spontaneously without a card via QR code and an internet connection. ebee charging points with their solid metal housing are ideal for public charging. They are optionally available in the basic model as wallboxes, charging points or as street lamp chargers.

The Cologne hotel operator sees their use as more than just a potentially higher number of overnight stays. "The two charging points are the perfect addition to our car park facilities, which we want to offer to hotel guests as well as external e-mobilists who are looking for a conveniently located green charging point in the centre of Cologne", explains Andreas Wörner, tenant of the hotel that belongs to the Kolping Society of Germany.

The model used at the city hotel is the first version of the ebee wallbox that complies with German calibration law. Since 1 April 2019 when the calibration law was enacted, German law has required the end consumer to be able to trace back previous charging and billing operations at public charging points. The ebee charging points are enabled for this by the Bender CC612 charge controller in combination with the certified "eHZ Mobility" meter from EMH. A cross-vendor transparency software developed by ebee and other members of the so-called SAFE initiative provides the backend communication of these components. Since spring 2019, ebee charging points allow energy to be invoiced in kWh via the backend in accordance with German calibration law.

In addition to the possibility of complying with German calibration law, Bender charge controllers also provide an excellent range of smart technology features that are usually only found individually in separate solutions. This explains the increasing importance of Bender technology for the charging infrastructure on the market. Along with ebee, numerous other charging point manufacturers have decided to install them, including well-known, international manufacturers. The widespread use of Bender technology automatically creates technologically advanced synergies between the individual charging infrastructure brands through installation, operation and maintenance.



Figure 2: Since 22 July 2019, the Cologne City Hotel has been operating two wallboxes from the Bender subsidiary ebee that comply with German calibration law. The 100 % green electricity used here is supplied by NATURSTROM AG.

TECHNICAL APPLICATION

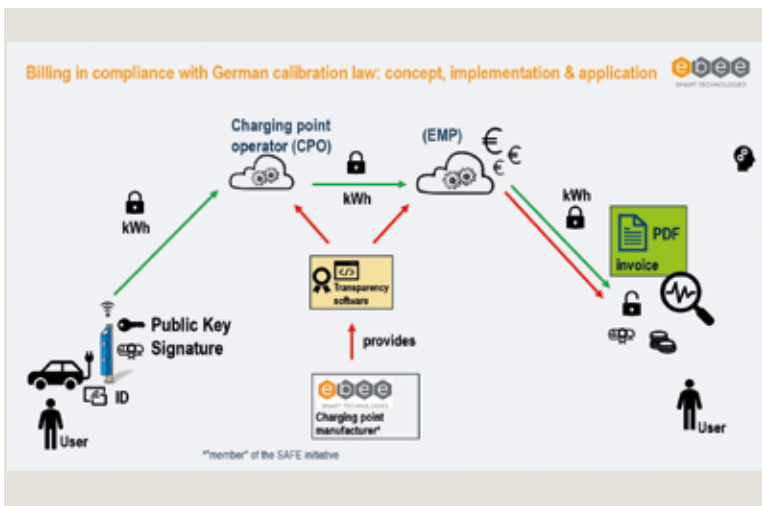

Figure 3: EV users can use public and private keys from the comfort of their home to verify the accuracy of past charging and billing processes: accurate, tamper-proof and repeatable at any time.



For example, charging point manufacturers can, if interested, obtain the expertise of the ebee team on how to make their own products comply with German calibration law on the basis of Bender charge controllers. "We even allow them to directly copy our approach to keep the effort for all parties involved in the certification process as low as possible. This of course is only practical when using the Bender charge controller", explains ebee CTO Robert Weyrauch. "Overall, we offer our customers maximum future-proof charging point operation," and the ebee Managing Director explains his product philosophy further, "this means future customer requirements with ebee charging points are already planned or can be realised via software updates."

Given the openness to development of electric mobility, this technology package for the Bender charge controller will be required for future operation of the charging infrastructure.

Based on this, customers and operators can also be confident that ebee charging points will have a broad smart charging portfolio that is open to development.

- Therefore, the well-known Bender fault current monitoring with integrated type A RCD fault current measurement and an integrated DC 6 mA RCMB residual current measurement in the charge controller produces a significant cost reduction, because: The purchase of a type A or B RCD in the sub-distribution system is no longer necessary.

- The Bender-eebe development team opted early on for the ISO 15118 standard, which defines a powerline communication via the charging cable (plug & charge) between the vehicle and the charging point. Charging authorisation without an RFID card is now just as possible as the future integration of the vehicle into network solutions. The latter will be indispensable in a future with a smart grid and volatile currents from renewable energy sources.

- On the other hand, the dynamic load management implemented using ebee charging points has met with great interest from car park operators and property project developers, because it keeps the costs for building mains connections within limits. DLM master/slave communication can be used locally, i.e. without a backend, to control up to 200 connectable slave charging points (via Ethernet or WLAN). The main installed power can be kept low by distributing the charging current intelligently over time, for example in car parks and underground garages. Even when expanding a previously existing charging point, mains connections can be kept constant. The available power is then distributed between the larger number of charging points dynamically and according to the needs of the vehicles. The external metering also offered by ebee rounds off the demand-driven variability of load management in the overall system.

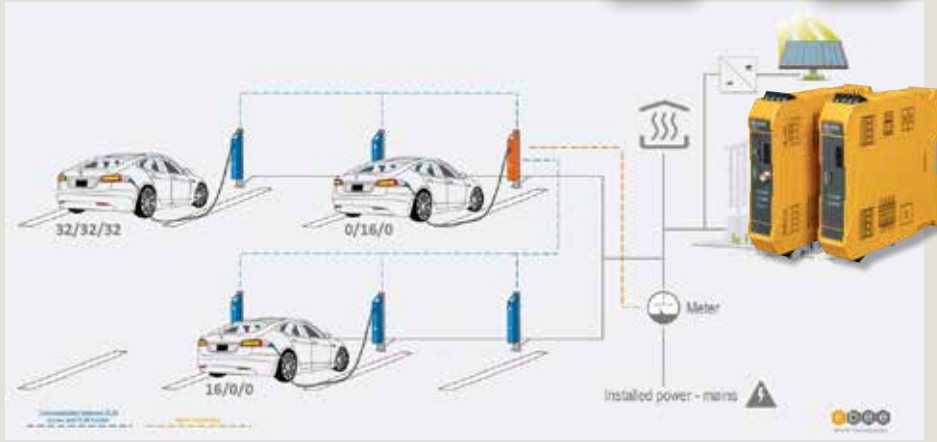

Figure 4: In particular, the DLM offered by ebee together with an external meter with Modbus connection meets the increased demand of the property sector.

Figure 5: ebee's charging point Berlin (3.7 kW / 11 kW / 22 kW) from ebee has been designed for outdoor use (stainless steel, IP54, IK10, forced-ventilated). Installation is possible as a wall-box on a wall or by means of the optionally available pole as a free-standing single or double column. The poles can be mounted on suitable solid ground (concrete floors) or on loose soil or earth using the supplied ground anchor.

- ebee attaches value to standard openness for backend operations: ebee charging infrastructure is compatible with all commercial backend solutions thanks to the Bender charge controller. Billing and charging point operation and maintenance can be handled conveniently from the office using the open OCPP protocol (currently 1.5 and 1.6 JSON/SOAP).
- ebee charging points can be flexibly adapted to local conditions even with regard to the technical communication between the authorisation receiver, charging points and the backend. Data connection can be either via 3G/4G modem, Ethernet, WLAN or even offline (without a backend connection) via RFID chip authorisation, or by local whitelist or FreeCharge. Charging point operators can therefore decide whether they want to define a closed loop of chargers or ensure public charging using backend operation with charging cards or direct payment. Earlier issues with charging card compatibility have almost been eliminated by systematic roaming.

The Bender and ebee developers seem to be on course with their technical and quantitative development. Whether intelligent energy control in the private smart home or public charging in the car park – the electric mobility of the future requires intelligent charging infrastructure.

By achieving German calibration law compliance, ebee has created the conditions for continuing to guarantee its own technical advantages within the scope of this regulation. The Cologne City Hotel at the Roman Tower will probably not need all the features right now, but the future can now unfold. Ultimately, with the installation of the two public charging points, the city hotel is making a contribution as a "co-designer of the urban transport revolution," explains Oliver Hummel, CEO of NATURSTROM AG, that supplies the stations with 100 percent green electricity. ■

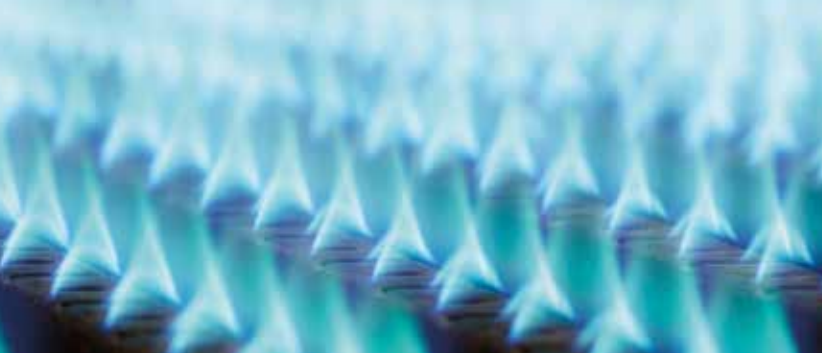

Bender makes coal seam gas production safe

Control concept allows insulation and well monitoring side by side

Coal seam gas is the generic term for all natural gases from coal. A distinction is made between coal seam gas and mine gas. Seam gas is also known as coal bed methane (CBM).

It is the gas still remaining in the coal seam: Together with the hydrogen contained in the organic material, the carbon forms the gas methane. Depending on the gas permeability of the surface layers, the methane remains in the coal as so-called coal bed gas. Composed of primarily 95-97% methane, coal seam gas is considered as an important source of energy with exploration and production having grown worldwide since the 1980s.

This unconventional form of natural gas typically occurs in coal seams at a depth of 300 to 1200 metres below the surface. It is released by drilling in the undissected rock or by elaborate drilling from above ground.

Production by drilling

Gas held within coal seams is adsorbed to the coal surface and held in place in a compressed state by water pressure. It can be extracted by reducing reservoir pressure which is achieved by drilling vertical wells through rock strata to the depth of the coal seam and pumping out groundwater. With the groundwater level remains above the coal seam, the reduction in water pressure associated with the groundwater removal enables the coal seam gas to desorb from the coal surface and flow freely through cracks in the coal seam up to the well bore. Water and gas may flow through separate pipes to the surface, or may be separated in a separator vessel at the wellhead and then pumped to relevant treatment facilities via separate pipelines (see Figure 1).

Submersible pumps in difficult environments

Electric submersible pumps (ESP) play an important role in the coal seam gas production process.

Installed at the base of the well and operating in a constantly changing and highly polluted environment containing silt, coal fines and other solids, electric submersible pumps face significant challenges in ensuring efficient and reliable operation.

Therefore, to ensure smooth and optimal performance of the production well, submersible pumps are often equipped with downhole sensors that provide a well monitoring system with critical data on pump intake pressure, motor temperature and system vibration. This data is used by an intelligent

control system to determine optimal production rate and to recognise equipment problems at early stages before a major failure occurs and shuts down the production process (see Figure 2).

Insulation and well monitoring in parallel

Due to the hazardous environment in which electric submersible pumps are used, insulation resistance monitoring of the pump motors and their power supply cables is just as important, if not more important, to ensure safe and uninterrupted drilling of the production wells.

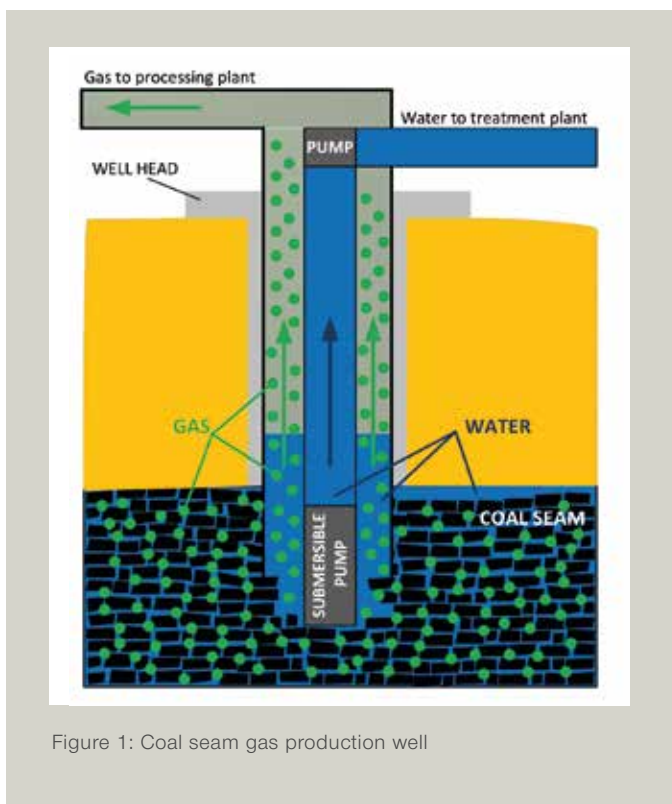

Figure 1: Coal seam gas production well

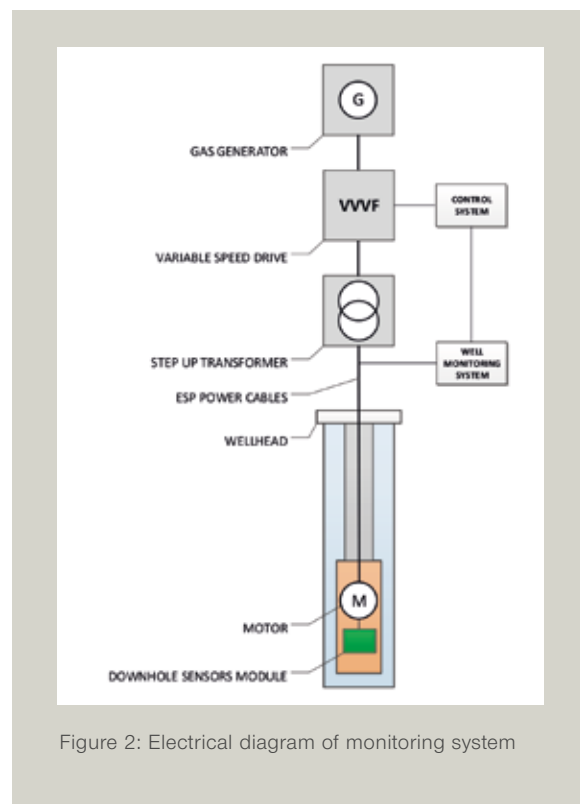

Figure 2: Electrical diagram of monitoring system

TECHNICAL APPLICATION

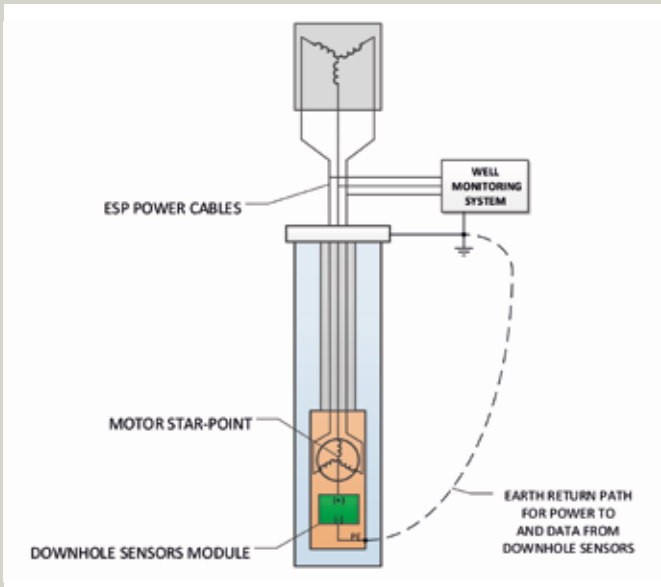

Figure 3: Electrical diagram of monitoring system



However, despite the importance of monitoring of insulation resistance, using of insulation monitoring devices are not always considered due to potential interference with well monitoring systems.

Usually downhole sensor modules do not require separate power and communication cables. Instead, a well monitoring system uses ESP power cables and earth return path via metalwork, to power and communicate with downhole sensors (see Figure 3).

As it can be seen in Figure 3, the downhole sensors module is connected with one pole to the star point of the motor's winding, and to PE with another one. The well monitoring system superimposes a DC voltage into 3-phase AC power to power the downhole sensors module, and communicate with the downhole sensors by modulating DC current. To monitor an insulation resistance of an electric submersible pump and EPS power cables, an insulation monitoring device needs to be connected between at least one phase of 3-phase AC power and PE.

An insulation monitoring device measures an insulation resistance by superimposing measuring voltage U_m and evaluating measuring current I_m that will be circulating in the system in the event of insulation fault R_f (see Figure 4).

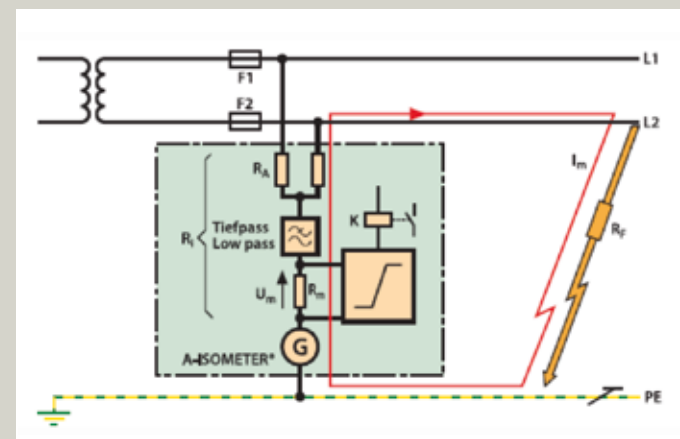

Figure 4: Operating principle of an insulation monitoring device

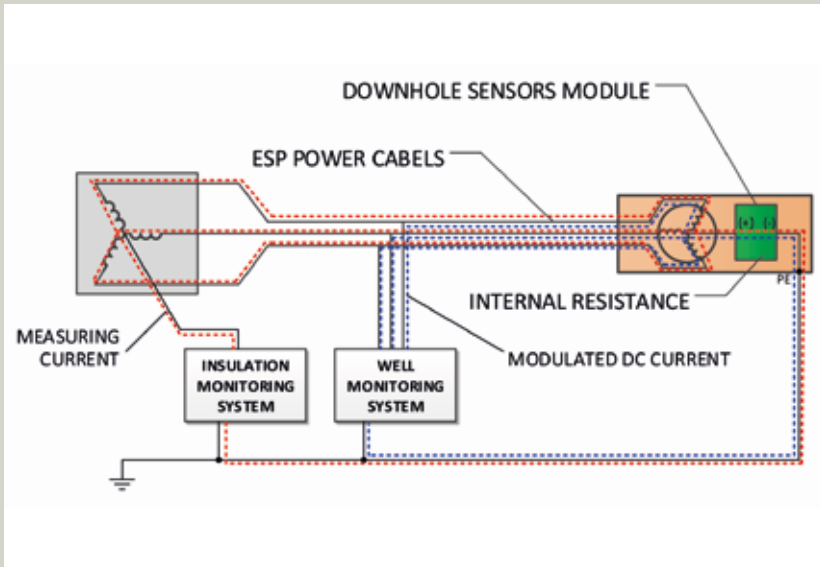

Figure 5: Interface between two monitoring systems

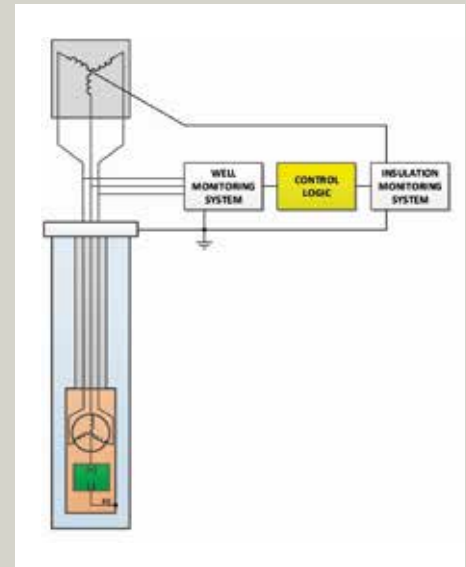

Figure 6: Control of well monitoring and insulation monitoring systems

Solution after in-depth analysis

Figure 5 below shows how well monitoring and insulation monitoring systems can influence each other.

The way how the downhole sensors module is connected to the pump’s motor, makes it impossible for two systems to operate simultaneously. As it is shown in Figure 5, the modulated DC current created by the well monitoring system takes the same path via EPS power cables and PE circuit as the measuring current generated by the insulation monitoring system. As a result, there might be interference between two these two currents, compromising functionality of each monitoring system.

However, there is one way to solve this problem. This is to implement a logic that will control insulation monitoring and well monitoring systems in a way that only one monitoring system takes measurements while another one is in “idle” or “stand-by” mode (see Figure 6).

This control approach can be easily implemented on Bender insulation monitoring device iso685-D that has a capability to switch between “active” and “stand-by” modes of operation from an external command.



TECHNICAL APPLICATION



Isolation monitoring device ISOMETER® iso685-D



Wellhead during commissioning



However, with well monitoring systems, switching between “active” and “stand-by” modes may appear to be not as straightforward process as with Bender insulation monitoring devices.

If a well monitoring system does not have a provision for an external control of operating modes, its implementation will require an engineering solution. There are a number of different well monitoring systems available in the market and there is no universal solution that will be suitable for all of them. A solution will require a detailed analysis of how a well monitoring system works and how it can be implemented without compromising the system’s performance.



iso685-D installed on the wellhead

Such a solution, however, based on the concept described in this article with the insulation monitoring device iso685-D at the wellhead for switching between the two systems and preceded by an analysis, has already been successfully tested by one of Australia’s largest coal seam gas producers and implemented in more than 40 wells. ■

*George Kotenko
Capacitor Technologies PTY Ltd, Australia*



TECHNICAL APPLICATION



Rotkreuzklinikum München | **Clinic of Gynaecology and Obstetrics**

Retrofit

of the operating theatre and the delivery rooms

With a total of 435 beds, **the non-profit Rotkreuzklinikum München** is an important Munich hospital with a focus on care. Since it opened in 1892, it has grown into an academic teaching hospital of the Technical University of Munich with more than 1,000 employees. It is divided into two operating sites, the Rotkreuzklinik in Nymphenburger Strasse and the Frauenklinik in Taxisstrasse.

As a specialist clinic for gynaecology and obstetrics with 145 beds and around 3,800 births each year, the Frauenklinik is Bavaria's largest gynaecological clinic and one of the largest maternity clinics in Germany.



▶▶▶ Retrofit – the challenge in hospitals

The renovation of operating theatres and delivery rooms poses a formidable challenge. Ongoing operations must be maintained, and the safety of the patients must be guaranteed at the same time.

This was the challenge faced by the Frauenklinik in 2018. The central power supply system of three operating theatres, two recovery rooms and six delivery rooms were to be renovated after more than 20 years of operation to bring it up to the state of the art.

The Technical Director of the hospital explains: "Bender provides the necessary flexibility for complicated renovation solutions without interrupting ongoing operations. The renovation during idle periods made it possible for the affected areas to largely avoid any disruptions to operations. It was also essential for us to save time and money by continuing to use the existing supply structures, such as cabling."



As a specialist clinic for gynaecology and obstetrics with 145 beds and around 3,800 births each year, the Frauenklinik is Bavaria's largest gynaecological clinic and one of the largest maternity clinics in Germany



The specifications for the renovation measures were driven by the existing infrastructure. No premises were available for the installation of a new system. The design of the existing switchgear meant it was also not possible to replace individual switchgear panels, making it necessary to reconstruct individual switchgear panels during operations. After a project manager from Bender Solutions GmbH & Co. KG had assessed the existing installation on site, these individually constructed systems were specially assembled and delivered ready-wired and mounted on wooden frames.

All the renovation measures were carried out by Bender service technicians without the need for any additional installation company. The installation activities were closely coordinated with the hospital and took place outside the regular hours of the operating theatres. The delivery rooms were fitted in as soon as they were free, thus avoiding any significant restrictions to the hospital's daily routine. The hospital's technical staff took care of the connection to the building control system, the on-site installation of new monitoring panels as well as the switching operations required as part of the renovation work.

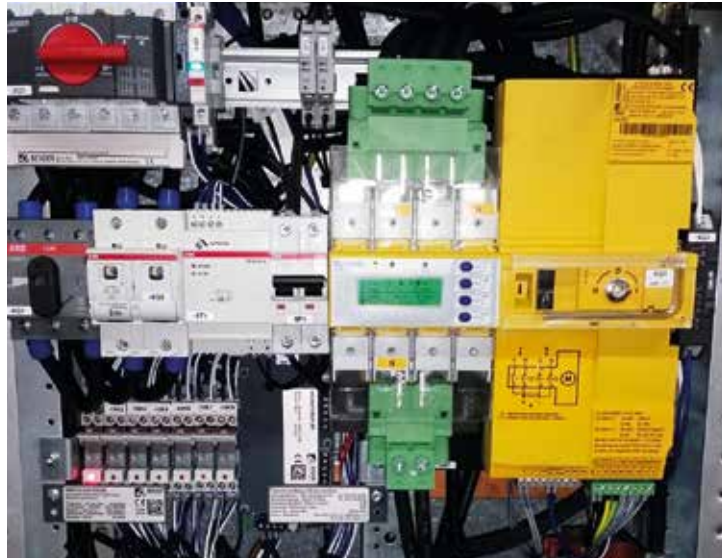

Bender supplied and installed a total of eleven isolated power panels, each supplied by BSV (battery-supported safety power supply) and SV (safety power supply), to ensure a redundant supply even under emergency power conditions. The high importance of the delivery rooms in the Frauenklinik requires that they are also supplied with IT systems. The distributors are equipped with TÜV-approved, automatic switching devices with monitoring for unearthed ATICS®-2-63A-ISO safety power supplies. All switching devices are equipped with a bypass switch for better maintenance. Two new isolating transformers were used per IT system. To reduce the thermal load, the ES710 series was implemented using the energy-efficient Green Line (GL) variant. The transformers, each with a power rating of 5 kVA and 6.3 kVA, were designed with 400 V on the primary side due to advantages regarding selectivity. The messages from the IT systems are displayed in each room by MK2430 alarm indicator and test combinations.

The renovation concept was drawn up in close consultation with the local registered inspector. With regard to optimum operational safety, the operating

The distributors are equipped with TÜV-approved, automatic switching devices with monitoring for unearthed ATICS®-2-63A-ISO safety power supplies.

company commissioned the BSV manufacturer to calculate the network and the total inrush currents. In addition, the overall system was re-symmetrised and the selective protection grading was comprehensively reviewed.

Quality and experience count

The renovation of the power supply system in the Frauenklinik was not an easy task. "We chose Bender's solutions because we can look back on many years of excellent cooperation with the market leader in the field of medical IT systems and we can, therefore, achieve system consistency across the premises. We will be happy to return to Bender's specialist knowledge and solutions for future renovation projects," emphasises the Technical Director of the Rotkreuzklinikum. ■

*Dipl.-Ing. Alexander Druse
TB Munich*

ISOMETER® iso685 and ISOSCAN® EDS440/441

Insulation monitoring system for 24/7 readiness for duty at sea

“Helgoland” and “Borkum” – what sounds like a fresh breeze and sea air is concentrated technology designed to ensure safety at sea. They are two seagoing customs vessels from the maritime unit of the German customs authorities and coast guard. Both require a powerful speed drive with a reliable power supply to operate 24/7 whatever the weather conditions. Equipping them with the Bender products insulation monitoring device iso685 and insulation fault locator EDS 440/441 has ensured this.



The customs vessel Helgoland in use on the German North Sea

As a part of the coastal force of the Federal Republic of Germany, customs vessels undertake monitoring tasks within the national sea borders and in the exclusive economic zone along the German coast. Customs officers are on duty at sea 24/7 preventing smuggling, monitoring the movement of goods and collecting customs and excise duties. The duties of the crew on board also include environmental protection at sea and the rescue of shipwrecked persons. A tightly timed schedule ensures that the crew can accomplish its numerous tasks: The Borkum and Helgoland are stationed in Cuxhaven and are both on patrol for one week on the North Sea. The Helgoland was put into service in 2009; the Borkum followed in 2010. After several years of deployment on the German shelf sea, individual electrical components on board were no longer state-of-the-art, did not comply with current standards and had to be upgraded to a current and robust state.

SWATH ships for ideal seakeeping behaviour

The Borkum and Helgoland are so-called SWATH ships. SWATH stands for “Small Waterplane Area Twin Hull” (catamaran). The cylindrical buoyancy bodies made of steel are under water and connected to the usable



View of the double hull of the SWATH vessel Helgoland © Carsten Müller

surface, i.e. the upper deck, by a bridge-like structure. A diesel-electric propulsion system permits a sailing speed of 20 knots (approx. 37 km/h) for ships of 49.35 m in length, 19.0 m in width and draughts of 4.55 m. Four 16 V 4000 M 40B MTU diesel engines, each with 2200 kW, supply two asynchronous motors from Siemens with 3800 kW each. Along with generating the propulsion power, they also ensure proper functioning of the on-board electronics.

Switching off individual loads can jeopardise sea safety

Insulation faults occur comparatively often due to the extreme conditions that man and machine are exposed to at sea. Normally, faults cannot be easily located due to the size and dimensions of the electrical installation and are traditionally isolated and identified by switching off the loads systematically.



View of the display: It's working!

© Carsten Müller



TECHNICAL APPLICATION



Measuring current transformers are important components for real-time insulation fault location
© Carsten Müller



The superintendent Torsten Krambeer explains the situation before the retrofit: "The insulation monitoring devices on board have been displaying fault messages with an unknown source. Different loads had to be switched off consecutively to find out the source of the fault. This is time-consuming and many of these measurements could not be made at sea because the sea safety of our ships is not guaranteed while loads are switched off. This kind of maintenance work can delay the departure of the ships by anything from a few hours to several days depending on the failure."

Comprehensive system analysis and goal setting

Nico Winkeltau, the on-board electrician of the Borkum, defined the goal as being able to automatically identify and isolate insulation faults so that they can be located in real-time with the lowest possible time requirement and without stopping. He identified a product range that has been established on the market for many years as a fundamentally suitable solution and this is how the insulation monitoring specialists from Bender came on board. In the beginning, application engineer Oliver Schultz and Maritime Business Development Manager Benjamin Greiff from Bender measured every distribution at all voltage levels on board the Borkum and laid out the future measuring system.



Discussion about the insulation fault monitoring system
© Carsten Müller



Function check
– Benjamin Greiff checks the insulation monitoring system

© Carsten Müller

By subsequently replacing the old insulation fault locators with state-of-the-art technology, a standard-compliant AC/DC measurement procedure according to IEC 61557-8: 2014 was implemented, which now protects both the crew and the equipment used.

All the required components in the Bender product portfolio are combined and were put together precisely for the customs vessel in the subsequent project phase.



440 V machine network monitoring with the assignment of insulation faults to the exact output
© Carsten Müller

Optimum support from the electrician on board

Oliver Schultz checked the dockyard installation as well as the settings and commissioning of the insulation fault locators. Now, even if there is no fault, you can see from the tree structure of the monitored outgoing circuits where and how much residual current and test current is flowing. Similarly, you can anticipate where the loads with the lowest insulation level are activated. All data is available via the locally protected WLAN and can be used anywhere on board. This allows the ship electrician to easily troubleshoot the situation using a tablet. At the same time, personnel costs are cut in half because nobody is required to give messages from the switchgear area in the engine control room and condition-based maintenance is possible. Michael Sievert, the electrician on board the Helgoland, explains: "In particular, communication and fault transmission via a web browser simplifies and accelerates the checking and rectifying of faults immensely. Thanks to the recorded trending of individual phase characteristics, we can now accurately compare the measurement results of faults so that the insulation fault can be located and rectified at sea 'in the blink of an eye' without losing valuable time at the pier."

View: One single configuration for a complete fleet

By using one device series in all systems, spare part management as well as replacing individual devices has become very simple. Today, ship operators can back up the settings of a complete insulation monitoring system 1:1, transfer it to identically constructed ships and quickly commission an automated insulation fault location system or replace devices.

The chief engineer of the Helgoland, Horst Brandt, puts it in a nutshell: "The possibilities that digitalisation has opened up for us are enormous and the reliable functioning of on-board electronics is fundamental to our work: Safety at sea is top priority."

At a glance:

Two customs vessels were to receive a standard-compliant insulation monitoring system.

Background:

The old insulation monitoring device installed on board provided non-specific insulation faults which could not be assigned. This jeopardised the sea safety of the ship and, as a result, two electricians had to troubleshoot each fault at the port, which was often a time-consuming process.

The solution:

A standardised measurement procedure for AC/DC (IEC 61557-8: 2014) has been implemented on board the maritime units Borkum and Helgoland and now insulation faults can be specified whilst the ship is at sea over 97 measuring channels in the 6 systems and can be resolved with the help of just one person with a tablet. ■

Digitalisation – everyone’s heard of it, everyone knows it, and it’s changing everything! How we live, how we work... Social media platforms such as Facebook and LinkedIn have become an important means of communication, not just for personal use but also in business including Bender. Social media provides opportunities for contacting and communicating with customers and the general public digitally.

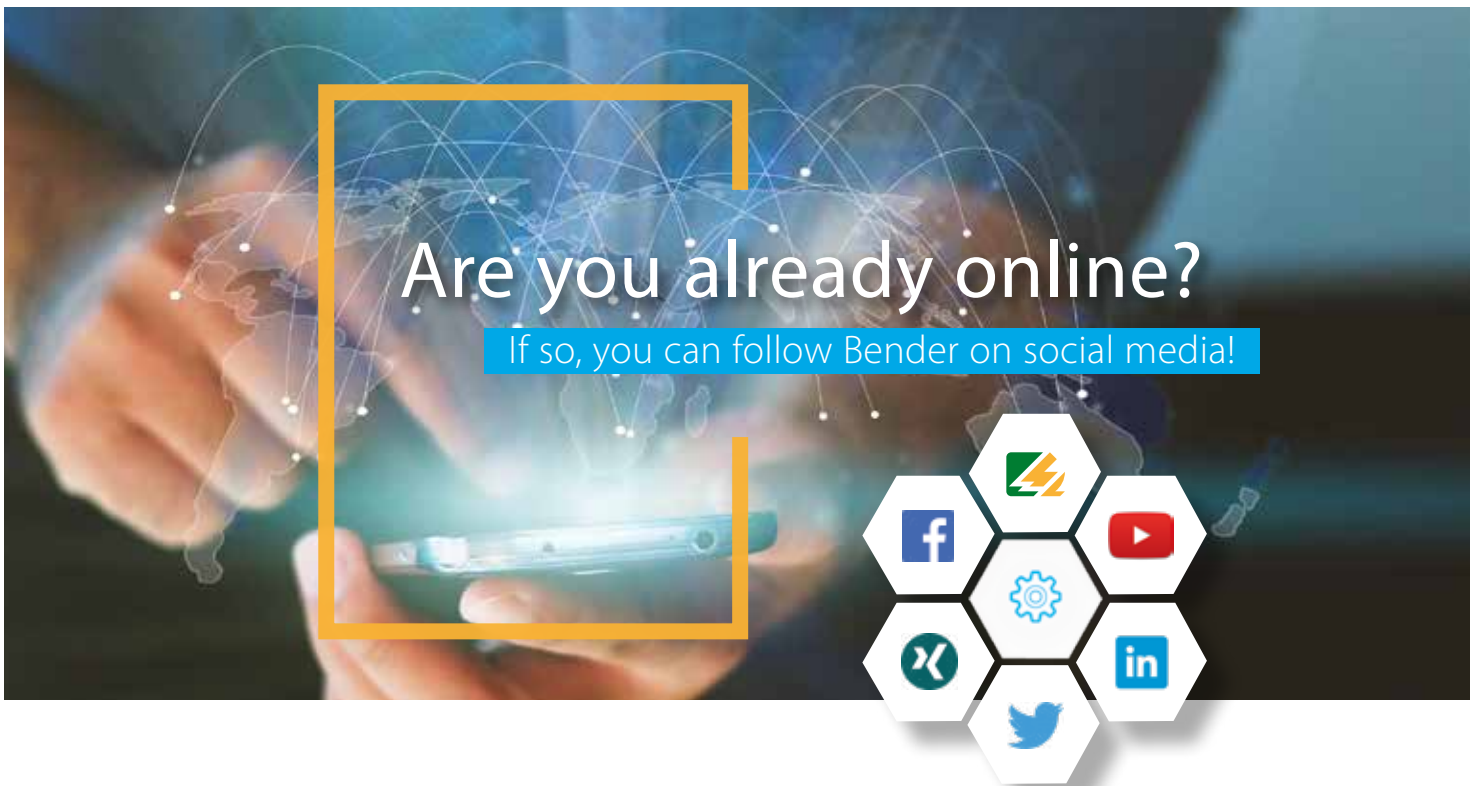

Media formats and the way we use them are changing. Traditional media such as TV, radio and print media, including brochures, catalogues, newspapers and specialist magazines are being used less and less. You may even be reading this article online rather than on paper.

Via "digital media" such as the Internet and various smartphone and tablet apps, social media's online communication channels provide users with a means of finding information quickly. News is

posted, and people network and exchange information. Users can like, comment or share information, follow it (e.g. by following company pages, etc.), become active, network with other users, communicate directly with them live or discuss ideas – anytime, anywhere. In other words, the most important distinction between social media and traditional media is interactivity.

Another special feature of digital media is the speed at which information can be distributed and



modified. Due to the rapid spread of knowledge, opinions and information, it has become essential to respond immediately in real time. Yesterday's stories are often today's old news.

Bender GmbH & Co. KG and its subsidiaries also have a global online presence that provides a wide range of information not only on company websites but also through social media presence. Examples include campaigns such as the information series about different types of power supply systems; ePush, a campaign by the eMobility business unit about providing a future-proof charging infrastructure, or examples of permanently available pumped-storage power plants.

We also regularly post on LinkedIn, Facebook, WeChat, Twitter, YouTube and most recently Instagram:

- Information about participation in exhibitions and events
 - *Normally published two to four weeks in advance and live from the fair*
- Seminars provided by the Bender Academy
- Specialist knowledge
 - *Linking of exciting specialist articles, news, website pages and articles from our customer magazine MONITOR*
- Product advertising
- Job vacancies
- Opening hours/emergency numbers during public holidays
- News about Bender and current projects
- Regional news
- Various series presenting image marketing films and explanatory films and videos
- Campaigns or regular weekly series such as #informationsdienstag (Facebook) / #informationtuesday (LinkedIn).

A traditional media presence is still important to Bender and this can be seen through our "MONITOR" magazine. ■

Stephanie Meyer
S-MAR

INTER- ACT WITH US!

Follow our company pages and keep up to date with our current activities and topics.
Stay informed, comment on articles and communicate with us and other users.
Pass on information and **share articles** with colleagues, friends and acquaintances.
 Just get in touch with us.

We'd love you to follow us.



BENDER INHOUSE



Bender acquires Eetarp

Southeast Asia is getting closer

On 31 January 2019, the **Eetarp Group**, consisting of Eetarp Engineering Pte Ltd. (Singapore), STE Systems Pte Ltd. (Singapore) and Eetarp Power (M) Sdn Bhd (Malaysia), was acquired by Bender and is now part of the Bender Group.

"**The combination** of Bender – as an established technology leader with a considerable knowledge base – and Eetarp – with its expertise and know-how as a regional company – **offers tremendous potential for the future.**"

Eetarp Engineering Pte Ltd was founded by Eric Er (Eric Soon Tuan) in 1999 and since then has been a local Bender agent. In the last 20 years the company has been successfully selling Bender products and solutions in Malaysia and Singapore. Eetarp specialises in the areas of Electrical Safety, Power Quality and Energy Management.

Eric Er talks about the company's beginnings: "My first contact with Bender was in 1999 when I met Matthias Schwabe, who at the time was representing Bender at the "Power Generation" fair in Singapore. This was when our cooperation began."

Three years after its formation in 2002, Eric Er expanded the business by setting up the branch in Kuala Lumpur in Malaysia, thereby establishing the basis for all Eetarp's future transactions. 2008 marked the achievement of a further milestone with the formation of STE Systems Pte Ltd. and the product portfolio was extended to include Disturbance Fault Recorders, Capacities Banks and Active power filters.

Products and solutions for many application fields

The full product portfolio of the Eetarp Group is used in different areas ranging from hospitals, data centres and transformer stations through to shopping centres or apartment buildings.

In addition to the products or components per se, one of the key objectives of Eetarp's business is to offer customers tailored solutions. This concept has been realised with Graphene®, a platform developed in-house and now supported by Eetarp's 25 employees. This places the focus on the added value to the customers and their satisfaction is guaranteed.

"Together with Eetarp we can optimally exploit the market opportunities in Asia. With this acquisition, we are not only increasing our local presence, but also, above all, opening up considerable future opportunities in a strategically important growth region. This will provide a substantial boost for our business in the region", says Markus Schyboll, Chief Executive Officer (CEO).

The cooperation with Eetarp and its headquarters in Singapore was already of significant economic importance for Bender in the past. Singapore – as one of the most powerful industrial nations worldwide – offers huge potential together with Malaysia. The relatively small city state, in which 5.6 million people live in an area as large as Hamburg and which has established itself as a



¹⁾ <https://www.smartcitiesworld.net/news/news/singapore-is-named-the-worlds-smartest-city-516>
<https://sosyalforum.org/digital-transformation-singapore/talent-key-to-sustaining-digital-transformation-for>

BENDER INHOUSE



▶▶▶ leading global "smart city"¹⁾, has become an economic hub for Asian markets. Political stability, protection of trademark rights and, last but not least, a highly developed infrastructure make Singapore particularly attractive as a business centre.

Utilising joint expertise

As Bender and Eetarp have now been operating in the same industry for two decades and have been able to amass a wealth of experience with each other through their long-standing cooperation, positive synergies can be directly utilised after the acquisition. The combination of Bender – as an established technology leader with a considerable knowledge base – and Eetarp – with its expertise and know-how as a regional company – offers tremendous potential for the future. This provides an excellent platform for expanding the business network in Asia and laying the foundations for a successful future in Asia.

To utilise this potential and ideally promote Eetarp as a new member of the Bender Group, particular emphasis will be on the close exchange between the two companies. For this reason, the long-time member of staff, Michael Breuer, has been posted to Singapore long term from the headquarters in Germany. Here he will expand existing structures and set new targets with the experienced APAC region team.

As a result, Bender will not only strengthen its position in Singapore and Malaysia, but in the whole of the Asia Pacific region, which will create large opportunities in an extremely fast-growing market as well as a stable foundation and a win-win situation for all the parties involved – for Bender, Eetarp and their customers. ■

*Michael Breuer, M.Sc.
Eetarp Engineering Pte Ltd*



Offshore

training and surveys

Improved safety for the coast:

Bender UK enhanced capabilities for offshore sectors

Often times on drilling sites and ships, production plants are in operation around the clock, meaning that a system shutdown due to a small electrical failure can be detrimental and costly.

To avoid unnecessary shutdowns and achieve a higher level of safety, Bender has enhanced its offshore survey and training capabilities. This not only addresses earth fault problems faced by operators of offshore oil and gas installations, but reduces the cost of non-productive time, in turn saving millions of pounds per year.

The advantages of such floating production facilities provided by Bender UK are extensive, as these improved tests are designed to assess and verify the condition of electrical systems and ensure devices are installed and functioning properly. Not only operational safety, but personal protection can be ensured through the application of unearthed IT-systems and their corresponding monitoring devices.

Bender insulation monitors make it easier to manage the integrity of topside critical power and communications systems, enabling intervention to be planned with minimum disruption to plant operations. This is done by providing an assessment of the overall health of critical electrical systems such as control, safety, fire, and gas systems.

Bender's experienced and certified Offshore-Technicians are able to locate, classify, and analyze earth faults on drilling platforms or vessels. Having learned that systems are not always used effectively, the Bender team provides maintenance engineers to respond to alerts. These teams work closely with oil and gas operators on a range of control systems, electrical distribution networks, and historic devices to help classify and eradicate faults to improve system health.

As a global expert in oil and gas electrical safety systems, Bender's insulation monitoring devices are a vital part of the critical infrastructure for offshore installations such as static platforms and FPSOs, ensuring compliance with safety regulations and preventing shutdown.



Overview

Bender isolation monitors allow for simplified and cost-efficient management of topside critical power and communications systems, thus enabling planned intervention with minimal disruption to plant operations. Furthermore, Bender's portable fault location equipment helps engineers locate ground faults in ungrounded AC and DC systems. ■

For more information contact:
industrialsales@bender-uk.com

Lisa Hudson, Marketing Bender UK



Mae Fah Luang Hospital,
Chiangrai

We make electrical safety simple

Simplify Engineering Co., Ltd. (SPF) was established in August 2011 by the leading engineer of the former Bender distributor together with other experienced engineers in the fields of design and installation. Since then, SPF Engineering has been selling power supply solutions and electrical systems as well as the associated engineering services. The company provides electrical safety in the planning and modernisation of medical facilities throughout Thailand.

The cooperation with Bender started in 1997 through Ulrich Lampe during the Hannover fair. The headquarters are located in the south of Bangkok, Thailand, and now have six employees.

Targets

SPF Engineering focuses on electrical safety and reliability for a wide range of applications, especially in medical locations and power distribution. Numerous renowned hospitals in Thailand, as well as international clinics, use Bender's proven technology for a safe and reliable power supply in operating theatres or intensive care units. The company benefits from the advantages of Bender products and the technical expertise.

Through cooperation with Bender, represented by Ulrich Lampe, SPF Engineering successfully supported the Engineering Institute of Thailand (EIT) in announcing and implementing IEC 60364-7-710 as standard for medical locations. According to this standard, the power supply in operating theatres must be designed as an unearthed power supply (IT system) for safety reasons. These medical IT systems were the first to be planned, developed and implemented in Thailand by leading engineers on the basis of this standard for medical locations.

SPF Engineering provides complete solutions and technical support for electrical safety in medical locations such as operating theatres, intensive care units and coronary care units. The product portfolio for medical locations not only includes isolated power systems from Bender,



but also commissioning and training for technicians and medical staff. This ensures highly efficient and reliable operation to offer comfortable conditions for patients and staff.

Not only the fast delivery by Bender, but also the existing and sufficiently available stock helps to ensure that customer requirements can be met quickly and that customers are supplied promptly.

As a leading provider of isolated power systems, SPF Engineering's customers include many renowned clinics and medical faculties, such as Siriraj Hospital (Mahidol University), Chakinarubordin Medical Center (Mahidol University), Songklanakarin University, Suranaree University of Technology, Mae Fah Luang University, Thammasat University, Walailak University or the Veterinary Teaching Hospital and the Faculty of Medicine of the Prince of Songkla University.



Mae Fah Luang University,
Chiangrai

AGENTS CORNER



▶▶▶ Projects and successes

A wide range of power quality monitoring devices and solutions to improve reliable power supply are also available, such as insulation monitoring devices or power quality and energy measurement (PEM) devices. SPF's employees always study and investigate each individual case in close cooperation with the customer's engineers to find the optimum solution, not only in the medical field.

For industrial applications, for example, the close cooperation with Bender and the use of Bender's IRDH275 insulation monitoring device ensure the reliability of the DC motor in the hot strip mill of the steel industry plant Sahaviriya Strip in Bang Saphan, Prachuabkhirikhan.

In the field of oil and gas production, for example, the team also works closely with Mario Zerbe from Bender Asia Pacific Co., Ltd and engineers from PTT Refinery and PTT Global Chemical Plants in Rayong to increase the reliability of their power supply system. In addition to products for insulation monitoring in unearthed systems (IT systems), EDS440 insulation fault locators are also used. Timely prewarning and precise localisation of the fault prevent unintended shutdowns of the plant and thus avoid costly damage.

Another solution recommended by SPF is to use Bender residual current monitoring systems (RCMS) in the earthed system (TN-S system) to monitor the earth fault current in order to avoid faults and damage to sensitive devices due to the high leakage current.

SPF also provides safety for a Thai state-owned company responsible for the production and distribution of drinking water: SPF offers offline monitoring with the ISOMETER® IR420D6-2 insulation monitoring device as a solution for the water treatment plants of the Provincial Water Works Authority (PWWA). This device monitors the insulation status of the motor and prevents damage due to insulation faults caused by water shortage.

In addition, SPF is supplying the Thai Oil Ware oil refinery in Laemchabang, Cholburi with Bender PEM735 and PEM333 power quality devices, including supervisory software, to monitor their network quality and energy management.

As a key factor of their success, SPF names the optimum support from the Bender staff in Grünberg and Bender Asia Pacific, as well as the consistently high quality and state-of-the-art technology of Bender products. Both are decisive factors that convince customers in Thailand to choose SPF.

The company would like to thank all employees of Bender and Bender Asia Pacific for their support. "Our long-term cooperation and partnership is the basis for our success", says Saprang Wisuthipanich, Managing Director of SPF. ■

Saprang Wisuthipanich
CEO SPF Engineering



EXHIBITIONS 2019 | 2020



EXHIBITIONS INTERNATIONAL

Pacific Marine Expo

21. – 23.11.2019
Seattle (Washington), USA

Europort 2019

05. – 08.11.2019
Rotterdam, Netherlands

BIXPO 2019

06. – 08.11.2019
Gwangju, South Korea

EP Shanghai 2019 & Electrical Shanghai 2019

06. – 08.11.2019
Shanghai, China

Medicall Mumbai 2019

13. – 15.12.2019
Mumbai, India

ELECRAMA

18. – 22.01.2020
Greater Noida, India

Operating Theatres Conference – ONECPD

13.02.2020
London, UK

IEEE ESW

02. – 04.03.2020
Reno (Nevada), USA

ASHE PDC Summit

22. – 25.03.2020
San Antonio (Texas), USA

GO MOBILITY

11. – 12.03.2020
Irun, Spain

IEE ESTMP

16. – 18.03.2020
Edmonton (Alberta), Canada

Maritime – related to oil & gas

26. – 28.03.2020
Beijing, China

ESA

08. – 10.04.2020
Pittsburgh (Pennsylvania), USA

EXPOMIN

20. – 24.04.2020
Santiago de Chile, Chile

EV Show

27. – 30.04.2020
Mississauga (Ontario), USA

Clinical Healthcare 2020

17. – 18.03.2020
Coventry, UK

EXHIBITIONS NATIONAL

Light & Building

08. – 13.03.2020
Frankfurt/Main, Germany



Hannover Messe 2019

20. – 24.04.2020
Hanover, Germany



Electric & Hybrid Vehicle Technology Expo

28. – 30.04.2020
Stuttgart, Germany



INFORMATION DAY

for industrial electricians of Electrosuisse
– Association for Electrical Engineering, Power
and Information Technologies

20.02.2020 Basel, Switzerland

03.03.2020 Bern, Switzerland

04.03.2020 Bern, Switzerland

31.03.2020 Pfäffikon, Switzerland

01.04.2020 Pfäffikon, Switzerland

02.04.2020 Pfäffikon, Switzerland

17.03.2020 Regensdorf, Switzerland

18.03.2020 Regensdorf, Switzerland

19.03.2020 Regensdorf, Switzerland

24.03.2020 Lucerne, Switzerland

25.03.2020 Lucerne, Switzerland

26.03.2020 Lucerne, Switzerland





Ruland Dahnke

Head of Division Marketing & Communication, Bender GmbH & Co. KG

CAREER OUTLINE

Ruland Dahnke is 47 years old, lives with his family in Neuss in North Rhine-Westphalia and commutes to Grünberg every week. He studied business administration with a major in Marketing and Controlling, worked in different leading roles in the B2B field for building and fire safety technology at a large international group for 14 years. He has been responsible for the field of Marketing and Communication at Bender since February 2019.

New challenges – focus on internationalisation and digitalisation

“We must think even more internationally!”

Mr Dahnke, you haven't been at Bender for very long. What responsibilities have you had so far and what were your ambitions for coming to Bender?

Since February 2019 I have been Head of Division for Marketing & Communication at Bender. For 14 years previously I had the opportunity to lead numerous projects in the field of marketing worldwide, but primarily in the European and Asian region. I already had plenty of contact with electrical building and safety technology. In addition, the life safety field is not foreign to me. It was therefore a completely natural and logical step to come to Bender. I find it fascinating to see the way that Bender as a German-speaking, export-oriented, medium-sized company has already decided to pursue this path and give it an even more international direction.

What particularly appeals to you about your new responsibilities as marketing manager?

Bender has great product ideas, innovations and stimulating collaborative projects and is able to sell these particularly well worldwide.

Who knew that a company from the rather small, quiet town of Grünberg would become the market leader in the field of the electrical safety technology. It is extremely exciting to see that technology constantly develops further. And consequently, to stay the market leaders, a company must continue to evolve. The competition never sleeps and follows the leader. We will probably be even better in three years' time. It is therefore important to think even more internationally. The development and expansion of digital marketing channels, for example, with websites and social media (LinkedIn and YouTube), are unavoidable. Digitalisation has already massively changed our lives and the working environment for everyone. Customers are increasingly on the go digitally and prefer to get their information online.

„**Digital processes and tools** are not only being used in marketing but are also being greatly expanded, enabling us to focus on customer service and **approaching the customer** .“

Internet distribution channels are becoming increasingly important. Is a B2B business without digitalisation still conceivable?

No. The digital transformation is continuing in huge strides and will have a strong impact in how we live and work in the future.

Digitalisation, according to the slogan “Bender Move Digital” and the shift towards the use of social media, has already doubled our number of followers within the last 12 months, with a significantly increased number of visitors to our website and greater use of Google Ads and our YouTube channel (up by 3 per cent) since August last year. In part, this has led to a peak of 77,000 hits on our web pages in one month.

What is your marketing concept for the future?

Digital processes and tools are not only being used in marketing but are also being greatly expanded, enabling us to focus on customer service and approaching the customer even better. Customers who still haven’t heard of the versatile products of Bender should be even better informed and be able to engage in a technical discussion with the sales department more easily. We have been making adaptations and showing current developments. It’s about conveying our service promise “We make electricity safe” at the appropriate communication levels and in sales talks and anchoring these ideas even more firmly in the minds of our customers.

What is the most important message to communicate?

If safety is your concern, then you must be able to provide appropriate advice and if need be play it safe and reject something, sometimes by saying no. We do not want manipulation, only honesty. I am pursuing this company philosophy. The “Bender” brand is a natural part of the marketing concept. The Bender brand provides orientation, creates confidence and gives meaning to our communications. The Bender brand needs to be exported to regions where people are not yet aware of the company’s excellent reputation. Bender as a brand is on its way to becoming

a global presence in its traditional core segments. In terms of digitalisation this means: In line with the “look and feel” slogan, the first impression will determine whether a customer will look at the displayed content more closely or not.

Since Bender is already active worldwide, what does internationalisation mean to you?

This step will be completed with the roll-out of specific product lines in the submarkets of various regions. This means that market conditions in India, for example, are also considered just like the existing traditional, known markets in Europe and the USA. This is shown in how the products are developed and the solution marketed. Internationalisation is also about being able to react to market needs locally. Moreover, it is about addressing the market directly based on existing tools.

What can we expect from Bender in the years to come?

In the field of electric mobility, for example, Bender is already at the very front within the group of automobile industry suppliers. Bender is also benefiting from a change in standards in Korea. I hope for continued strong growth and further expansion of the company. Anyone who is connected to Bender should want to continue to do so in the future.

Complete the sentence: “Bender for me is”

a great company with a fascinating success story, an excellent team and a very positive atmosphere, and an exciting new challenge and opportunity to connect professional satisfaction with success. Where there is a will there is also an (international) way.

Mr Dahnke, thank you very much for the interview. ■

*Michaela Heck M.A.
textwerk*

Practical Page A

Expertise

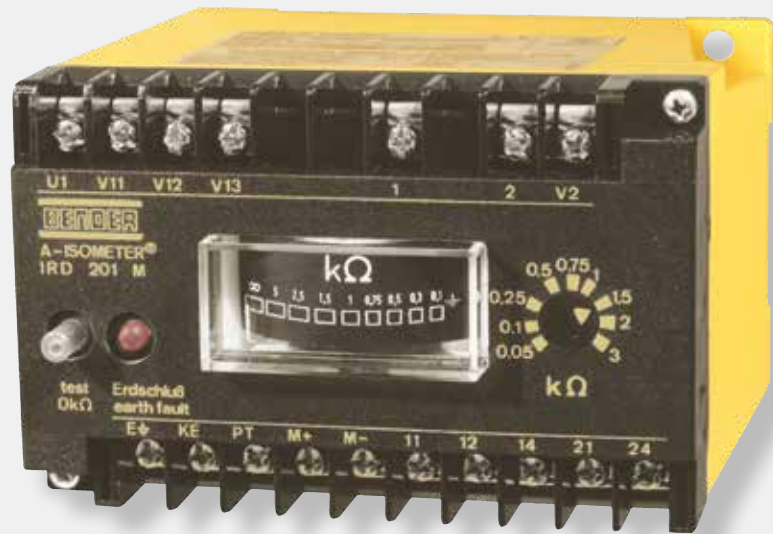

Insulation monitoring device
for use in AC systems

Retrofitting requirement for monitoring devices

The term "grandfathering" has become established in the field of electrical installations. It originates from building law and describes that the owner of a building lawfully erected at the time of construction is protected from legal changes which would not permit the renewed construction.

There is therefore no obligation to adapt, even if laws or regulations change. If the outside of a building that has been lawfully constructed is destroyed by fire, the owner has the right to rebuild it in the same location, exactly as it was before, i.e. without add-ons or modifications, even when the rebuild violates current building law requirements.



Practical Expertise



The situation is similar in the field of electrical installations. An installation thus complies with the rules of technology if it has complied with the relevant regulations at the time of installation. However, grandfathering rights are always excluded in electrical installations when:

- **The installation has been extended or modified**

see DIN VDE 0100-100:2009-06

134.1.9 *In the event of an extension or modification to an existing installation, it must be determined that the features and conditions of the existing equipment [...] are suitable for the modified installation. [...]*

- **A change in the operating conditions of the installation has taken place**

see DIN VDE 0105-100:2015-10

4.1.101 *Electrical installations are to be maintained in proper condition in accordance with the installation standards. If the operating conditions [...] change, the existing installations must be adapted to the applicable installation standards.*

- **An obligation to adapt has been pronounced**
(e.g. "Retrofitting requirement of RCDs for assemblies for construction sites")

- **The installation presents a hazard.**

A typical example from practice is the use of power electronic equipment such as frequency converters in an installation where no such equipment was available at the time of installation. This represents a major change in the operating conditions and may affect the functioning of the protective and monitoring devices used.

Although an insulation monitoring device compliant to DIN EN 61557-8 is not a protective device, it is a necessary monitoring device and represents an essential component of the overall concept for the protection of persons against electric shock in unearthed systems. A first insulation fault can be rectified in good time only when it is quickly detected and reported by the insulation monitoring device.

A monitoring device can be deemed no longer appropriate at the latest at the periodic inspection of the electrical installation by an authorised person. In case of doubt, the manufacturer can provide information on the appropriate use. ■

*Dipl.-Wirtsch.-Ing. Michael Faust,
Bender Academy*



Further literature on the subject:



Wilrich

Bestandsschutz oder Nachrüstpflicht?
VDE-Schriftenreihe 172
ISBN 978-3-8007-4531-9

Ensmann, Euler, Eber

Anlagenbetreiber Elektrotechnik
und verantwortliche Elektrofachkraft
VDE-Schriftenreihe 135
ISBN 978-3-8007-4162-5

BENDER Group

The Bender Group with its main office in Gruenberg/Hesse has 70 representations and 14 subsidiaries with nearly 822 employees worldwide.

You can find your regional contacts at www.bender.de.



Bender GmbH & Co. KG
Londorfer Str. 65 • D-35305 Gruenberg / Germany

Fon: +49 6401 807-0 • Fax: +49 6401 807-259
E-Mail: info@bender.de • www.bender.de

Power in Electrical Safety

Find Bender on



Facebook



Twitter



LinkedIn



Xing



YouTube



BENDER Group